

Blackout Instructions

4" Skyline Pocket Installation – Outside Mount

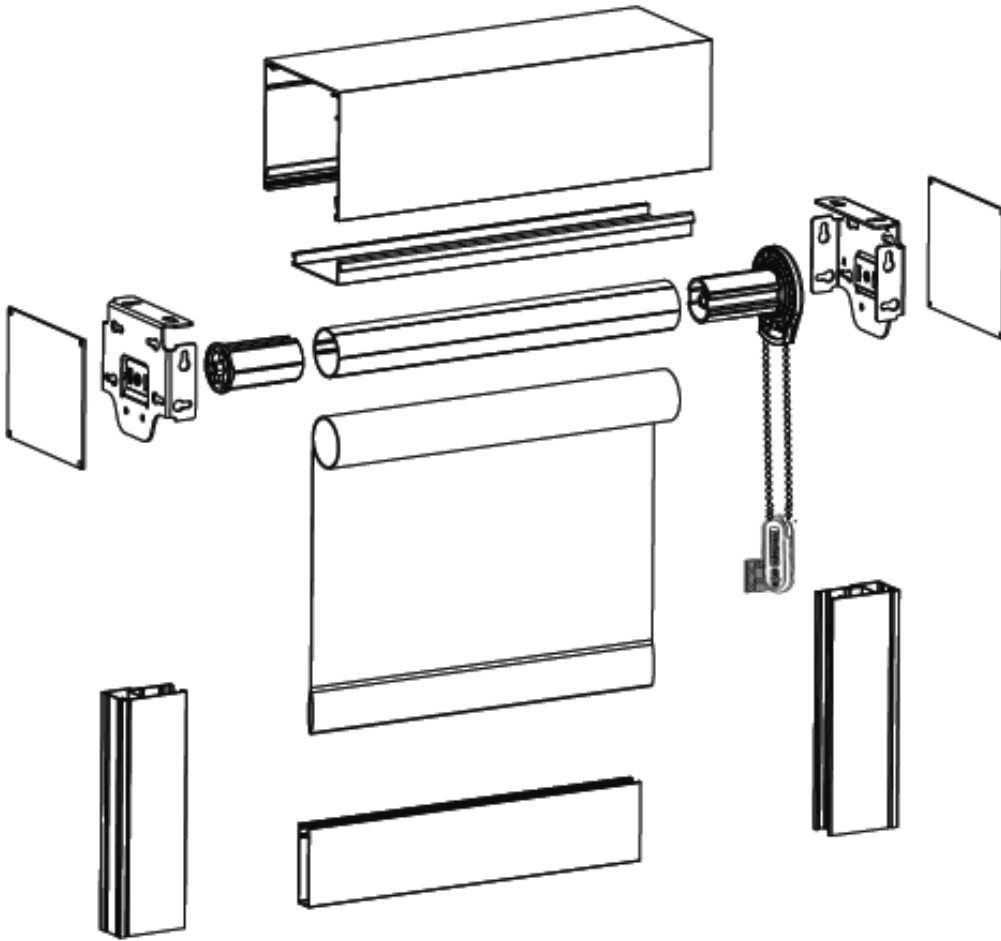



Components Needed _____ *page 3*

Tools Needed _____ *page 4*

System Diagram _____ *page 5*

Instructions

Step 1: Install Pocket _____ **Page 6**

Step 2: Install Brackets _____ **Page 6**

Step 3: Install End Plates _____ **Page 7**

Step 4: Mount Side Channels _____ **Page 7**

Step 5: Install Shade _____ **Page 8**

Step 6: Install Front Side Channel _____ **Page 9**







Step 7: Install Bottom Channel _____ **Page 9**

Step 8: Install Bottom Closure _____ **Page 10**

Step 9: Install Tension Device _____ **Page 10**

Blackout Instructions

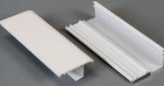
4" Skyline Pocket Installation Instructions

Quantity	Description	Image
1	4" Roller shade assembled to tube with clutch and idler inserted.	
2	4" Skyline Fascia Brackets	
2	End Plates	
1	4" Pocket	
1	Bottom Closure	
2	Front & Back Side Channels	
1	Bottom Channel	

Blackout Instructions

4" Skyline Pocket Installation Instructions

Tools Needed

Screwdriver/Power Drill
1/16" Metal Drill Bit
Screws
Hammer/Mallet
Measuring Tape
Level
Ladder
Chisel
Center Punch
Eye Protection
Gloves

System Diagram

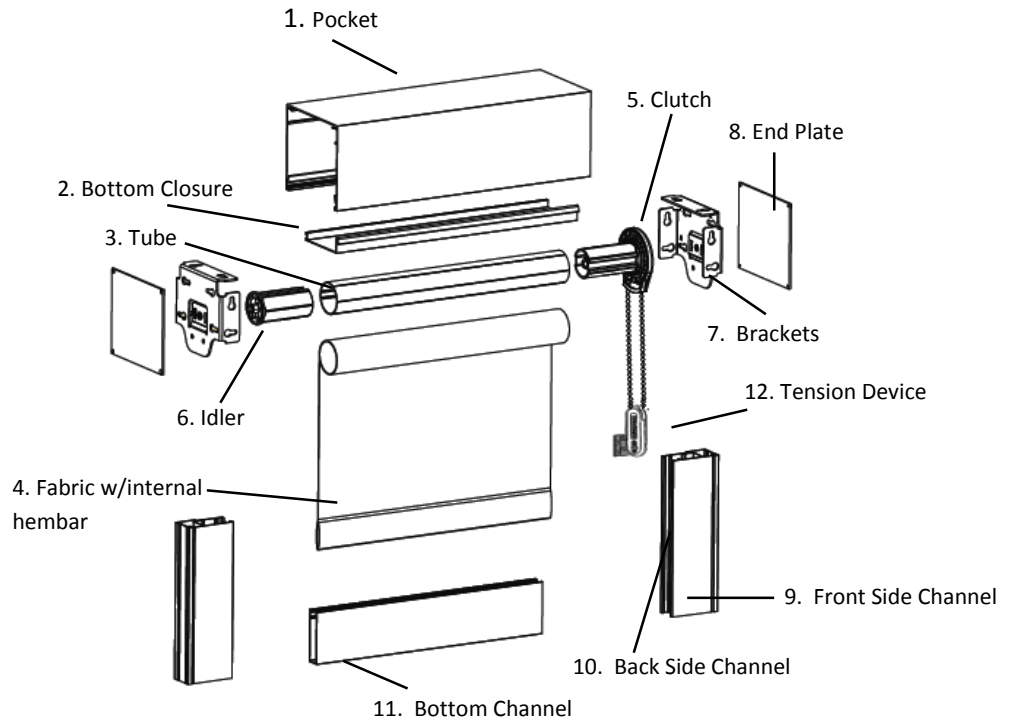

1	4" Pocket
2	Bottom Closure
3	Tube
4	Fabric with internal Hembar
5	Clutch
6	Idler
7	4" Skyline Fascia Brackets
8	4" End Plates
9	Front Side Channel
10	Back Side Channel
11	Bottom Channel
12	Tension Device

Blackout Instructions

4" Skyline Pocket Installation Outside Mount

Step 1: Install Pocket (Ceiling Mount Only)

- 1a. Mark mounting screw hole locations with a center punch
- 1b. Pre-drill mounting screw holes
- 1c. Mount pocket to wall or ceiling using the appropriate mounting screws

1a.

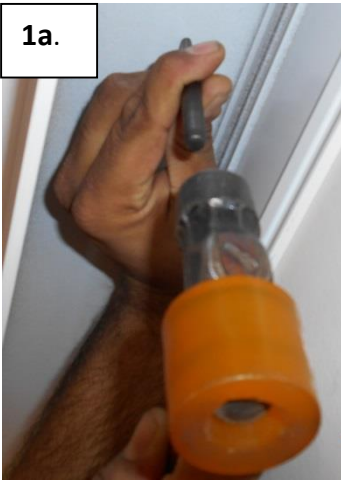

1b.



1c.



Step 2: Install Brackets

- 2a. Insert Bracket into pocket (may need mallet to gently tap bracket into place) until flush with end of pocket
- 2b. Secure bracket to pocket with supplied mounting screws OR:
- 2c. Secure bracket to pocket by staking pocket channel to bracket with a chisel.

2a.



2b.



2c.



Step 3: Install End Plates

3a. Insert End Plate screws into manufacturers pre-drilled holes in end plate and secure to pocket.



Step 4: Mount Back Side Channels (follow steps for right and left back side channels)

4a. Decide where to drill holes. Align Back channel under corner of pocket so that the side of the back channel is flush with the end plate and perpendicular to the pocket.

4b. Mark mounting screw hole locations with a center punch

4c. Pre-drill holes in the back of the side channel using 1/16" metal drill bit

4d. Re-align the back channel and mount with the correct mounting screws

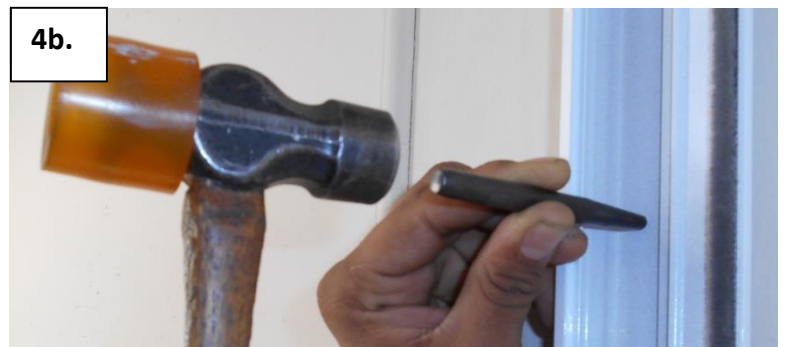

Step 5: Install Shade

5a. Insert Clutch side first by engaging the hooks on the clutch into the rectangular holes in the bracket.

5b. Insert Idler by pushing in the spring loaded pin and sliding the idler up the bracket until the pin end engages into the hole in the center of the bracket

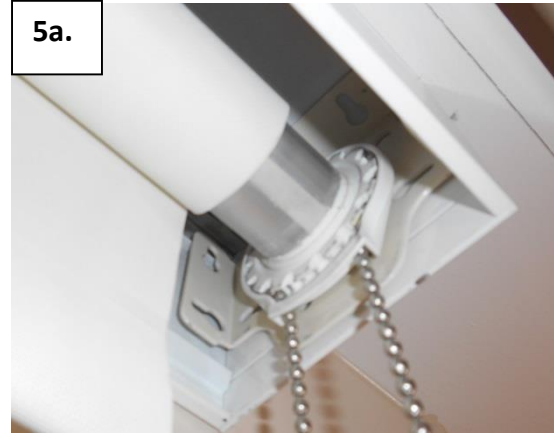

Step 6: Install Front Side Channel

4a. Snap front side channel by engaging lip of front side channel into the groove on the back side channel the snapping closed into place

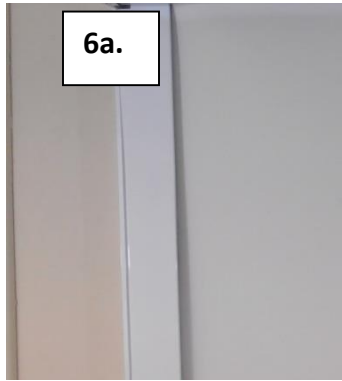

Engage lip into groove



Snap into place



Step 7: Install Bottom Channel

5a. Place left side of bottom channel between the front and back side channels
 5b. Slide the right side down in between the front and back side channels until the bottom closure is at the bottom of the side channels
 5c. While holding the bottom closure in place, drill a a screw hole using a 1/16" metal drill bit 3/8" from the bottom left hand corner of the side and bottom channel and install mounting screw through both channels.

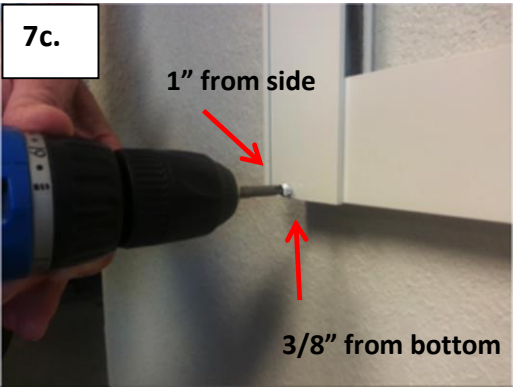

Step 8: Install Bottom Closure

8a. Insert bottom closure into pocket on an angle (as shown).

8b. Once it is aligned in shade, allow front of bottom closure to drop in place



Idler Side



Clutch Side



Idler Side



Clutch Side

Step 9: Install Tension Device



