



kirsch®

Custom Real Wood & Faux Wood Blinds

Suggested Retail Pricing  
Effective April 2015

## Table of Contents

### PRODUCT GUIDE

How to Measure	3
Product Details	4
Options and Upgrades	5–6
Hardwood and Variance Finish Index	7
Resemblance™ Faux Wood Index	8
Decorative Tapes Color Index	8
Color Coordination Reference Guide	9
Cornices	10–11

### PRICING

<b>Price Group A</b> – 2" Resemblance™ Classique™ Value Faux Wood Blinds	12–13
<b>Price Group B</b> – 2" Resemblance™ Faux Wood Blinds	14–15
<b>Price Group C</b> – 2½" Resemblance™ Faux Wood Blinds	16–17
<b>Price Group D</b> – 2" Resemblance™ Faux Wood Blinds	18–19
<b>Price Group E</b> – 2" Classique™ Variance Faux Wood Blinds	20–21
<b>Price Group F</b> – 2" Classique™ Value Hardwood Blinds	22–23
<b>Price Group G</b> – 2½" Resemblance™ Faux Wood Blinds	24–25
<b>Price Group H</b> – 2" Variance Faux Wood Blinds	26–27
<b>Price Group J</b> – 2" Hardwood Blinds	28–29
<b>Price Group K</b> – 1" Hardwood Blinds	30–31
<b>Price Group L</b> – 2½" Hardwood Blinds	32–33
<b>Price Group M</b> – 2" Hardwood Blinds	34–35
<b>Price Group N</b> – 2" Hardwood Blinds	36–37
<b>Price Group O</b> – 1" Hardwood Blinds	38–39
<b>Price Group P</b> – 2½" Hardwood Blinds	40–41
<b>Price Group Q</b> – 2" Hardwood Blinds	41–43
Exploded View for 2" and 2½" Slat Size Blinds	44
Exploded View for 1" Premium Hardwood Blinds	45
Cleaning and Care Instructions	46
Terms and Conditions	47
Kirsch Trust Warranty	47

## How to Measure

### INSIDE MOUNT INSTALLATION

#### TO FIND WIDTH

Measure exact distance to the nearest 1/8" between inside surfaces of window frame at the top, middle, and bottom, and use the narrowest width. Do not take any width deductions. Factory will take the appropriate deductions.

#### TO FIND HEIGHT

Measure exact distance to the nearest 1/8" from inside surface at top of window to sill at the left, middle and right and use the longest height. If you prefer blind not to touch sill, deduct 1/4". If there is no sill, measure height to point where blind is to reach.

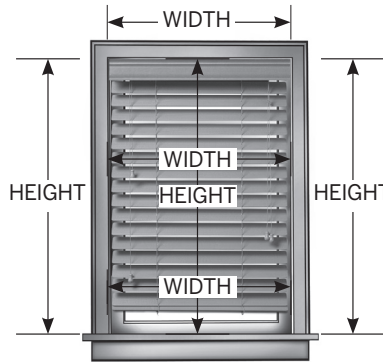

#### STANDARD FACTORY DEDUCTIONS FROM ORDERED WIDTH:

Headrail	-1/2"
Slat Width	-1/2"
Valance	-1/8"

### CRITICAL DIMENSIONS

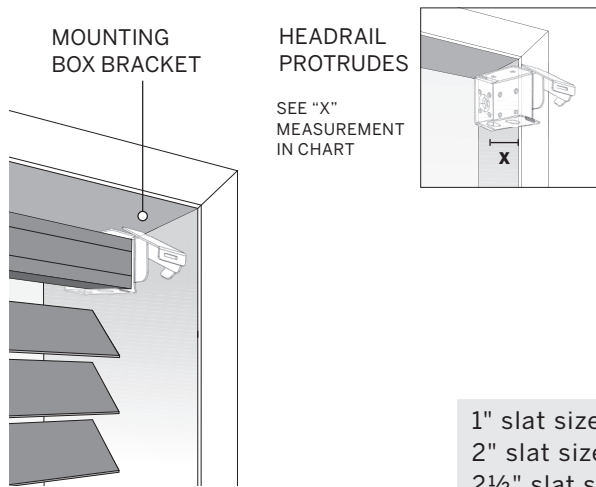

**HEADRAIL PROTRUDES**  
SEE "X" MEASUREMENT IN CHART

**HEADRAIL FLUSH**  
SEE "Y" MEASUREMENT IN CHART

**VALANCE FLUSH**  
SEE "Z" MEASUREMENT IN CHART

#### MINIMUM MOUNTING SURFACE

HEADRAIL DIMENSIONS HEIGHT X DEPTH	HEADRAIL PROTRUDES CLEARANCES NECESSARY FOR EITHER SIDE, BACK OR TOP MOUNT	HEADRAIL FLUSH MOUNT	VALANCE FLUSH MOUNT*
1" slat size 1" x 1 1/2"	1/2"	1 3/4"	2 5/8"
2" slat size 1 1/2" x 2 1/4"	3/4"	2 1/2"	3 1/2"***
2 1/2" slat size 1 1/2" x 2 1/4"	1 1/4"	3"	3 7/8"***

### OUTSIDE MOUNT INSTALLATION

#### TO FIND WIDTH

Measure exact distance to the nearest 1/8" between the outermost points where the blind is to be placed. For optimum light control, this measurement should extend at least 3/4" beyond the window opening on each side (or 1 1/2" for the entire width).

#### TO FIND HEIGHT

Measure exact distance to the nearest 1/8" from where top of blind will be located to top of sill. If there is no sill or if blind is to overlap window frame, measure to point blind is to reach.

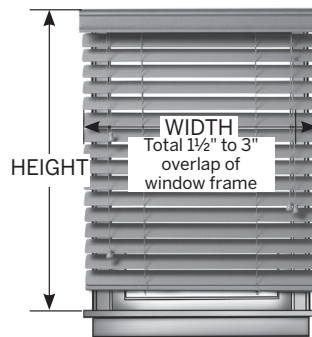

#### STANDARD FACTORY DEDUCTIONS FROM ORDERED WIDTH:

Headrail	-1/2"
Slat Width	0"
Valance	+1"

### VALANCE RETURN MEASUREMENT

To measure outside mount valance return length, measure the inside return length of the valance as shown. Minimum return length is 3/4", maximum is 6".

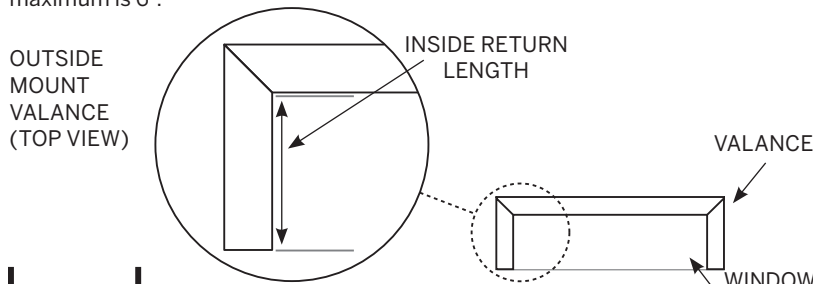

#### OUTSIDE MOUNT STANDARD VALANCE RETURN

WOOD/FAUX BLIND	INSIDE RETURN LENGTH*
2" Cordless	3 1/8"
2 1/2" Cordless	3 1/2"
2" Corded	2 7/8"
2 1/2" Corded, Cord Tilt	3 1/4"
2 1/2" Corded, Wand tilt	3 1/2"
1" Corded	2 1/8"

\*These dimensions are for an outside mount blind with an outside mount valance. For an inside mount blind with an outside mount valance, a custom return length should be chosen. Otherwise, standard returns will need to be cut to size at home.

Product Details

PRODUCT CATEGORIES

**HARDWOOD**

- Unsurpassed selection of natural real wood finishes and window solutions
- Coordinates perfectly with Kirsch Variance finishes
- Available in 1", 2" and 2½" slats

**VARIANCE™ FAUX WOOD**

- Highest quality, lightweight faux wood material
- Moisture, scratch and sun resistant
- Perfect for kitchens, bathrooms and sunrooms
- Coordinates perfectly with Kirsch Hardwood finishes
- Available in 2" slat

**RESEMBLANCE™ FAUX WOOD**

- Attractive value
- Everyday resilience
- Coordinates with Kirsch Resemblance Vertical Blinds
- Available in 2" and 2½" slats

PRODUCT PERFORMANCE COMPARISON TABLE

Kirsch®	Resistance to slat warpage	Resistance to UV Fading	Lift weight* (approx. 36" X 60")
Resemblance Faux Wood	Good	Better	Good (9 lbs)
Variance Faux Wood	Best	Better	Better (8.5 lbs)
Hardwood	Better	Best	Best (5 lbs)

\*Weight of slats and bottomrail only. This weight does not include valance, headrail or componentry weight as these are stationary when the blind is raised/lowered.

VALANCE DIMENSIONS

ITEM	DESCRIPTION	DRAWING #	VARIANCE & RESEMBLANCE DRAWING #
1	1" Hardwood Valance	SX###011	n/a
2	2" and 2½" Modern Valance	SX###004	SG###0111
3	2" and 2½" Traditional Valance	SX###009	SG###0110
4	2" Classique™ Value Valance	SX###016	L25P0108

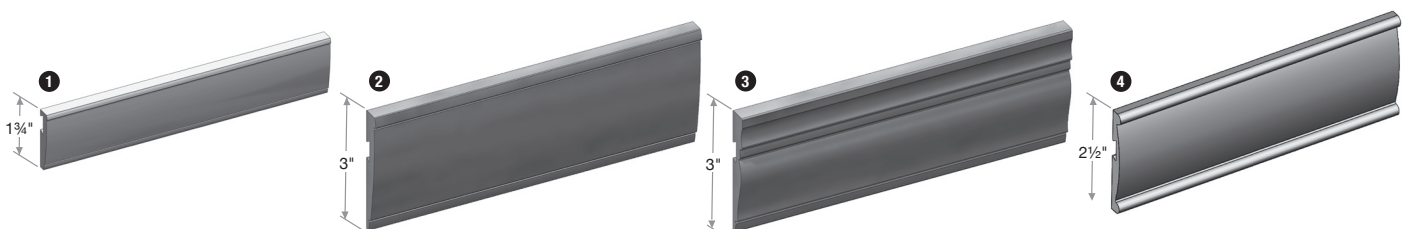

NOTE: Widths over 96" will require a splice for Inside mount and widths over 95" for Outside mount will require a splice.

Options

AVAILABILITY

	2½" HARDWOOD	2" HARDWOOD	1" HARDWOOD	2" VARIANCE™	2½" RESEMBLANCE™	2" RESEMBLANCE™	2" CLASSIQUE™ VALUE*
Cordless	O	O	—	O	O	O	—
Privacy	O	O	—	O	O	O	O
½" Tapes	O	O	O	O	O	O	O
1½" Tapes	O	O	—	O	O	O	O
Cord Tilt	S	S	—	S	S	S	S
Wand Tilt (standard on cordless)	O	O	S	O	O	O	O

S=STANDARD O=OPTIONAL —=NOT AVAILABLE

\*Includes Hardwood, Variance and Resemblance.

FREE OPTIONS

TRADITIONAL OR MODERN STYLE PACKAGE

A Kirsch exclusive for wood blinds designed to enhance your décor at no additional charge. Available on 2" and 2½" blinds only. See page 4 for images of both valances.

TRADITIONAL

Reflects the fine detailing of architectural accents in your home.

MODERN

A streamlined silhouette for a polished look.

TRADITIONAL

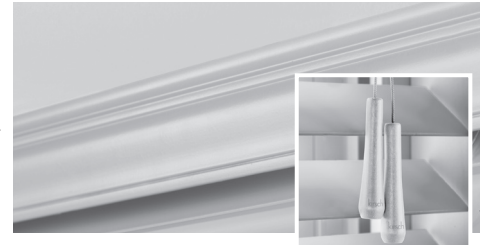

MODERN



EXTENSION BRACKETS

For installations requiring additional space between the blind and the mounting surface.

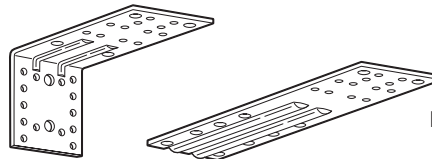

EXTENSION BRACKETS

HOLD-DOWN BRACKETS

Hold-down brackets prevent blinds from swaying. They can be sill mounted, face mounted or mounted inside the frame. Recommended for French doors and in windows subject to wind exposure. Must be requested at time of order.

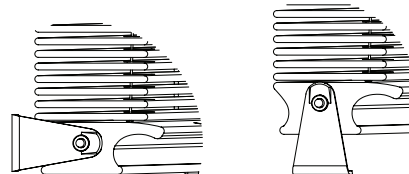

HOLD-DOWN BRACKETS

CONTROL POSITIONS

Choice of control position is available. Tilt left, lift cord right is the standard position. You may choose to reverse the standard position. Grouped controls, both tilt and lift controls on the same side, available on Hardwood.

WAND TILT CONTROL

Available in place of cord tilt. Wand tilt standard for 1" Hardwood and Cordless blinds.

CORD TILT CONTROL

Standard control not available on Cordless and 1" Hardwood blinds.

Tilt Control Length
OVERALL_LENGTH 30 - 12
30 < OVERALL_LENGTH 48 - 24
48 < OVERALL_LENGTH 72 - 36
72 < OVERALL_LENGTH 48

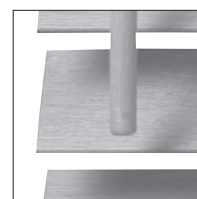

WAND TILT



CORD TILT



CLASSIQUE™ VALUE CORD TILT

## Surcharge Options

### PRIVACY

Edge route design provides tighter closure to minimize light for increased privacy and security. Slats can easily be removed for cleaning. Not available on 1" blinds or blinds with decorative tapes.

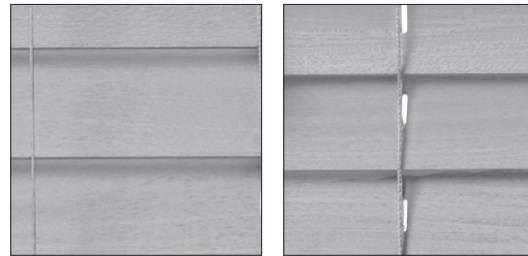

PRIVACY

STANDARD

### DECORATIVE TAPES

Accent your blinds and coordinate with your upholstery and textiles. Available in place of standard braided ladders. Not available with Privacy.

DECORATIVE TAPES AVAILABILITY	
SOLID	PATTERN
2½" slat size—1½" or ½" wide tape	2½" slat size—1½" wide tape
2" slat size—1½" or ½" wide tape	2" slat size—1½" wide tape
1" slat size—½" wide tape	

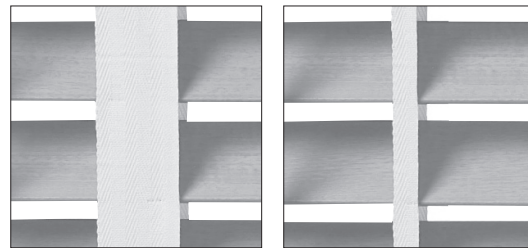

1½" TAPE

½" TAPE

### EXTENDED VALANCE OPTION

May specify a valance greater than ordered headrail width. Maximum total valance width is 144". Valance greater than 96" will be spliced. Must be requested at time of order.



2 BLINDS ON 1 HEADRAIL

### REPLACEMENT VALANCE OPTION

Maximum total valance width is 144". Valance greater than 96" will be spliced.



3 BLINDS ON 1 HEADRAIL

### MULTIPLE BLINDS ON ONE HEADRAIL

Provides the flexibility of raising one blind while keeping the other lowered. Two or three blinds on one headrail are available up to a total maximum width of 144". Inner space is ½" between blinds. Horizontal slat alignment not guaranteed.

### CORDLESS CONTROL

The design of our Cordless control creates a clean profile across all of your windows and makes it easy to lift and lower your blinds without dangling cords. Not available on 1" Hardwood or Classique™ Value.

\* An additional tolerance of minus 0" to plus 3" is acceptable.



CORDLESS

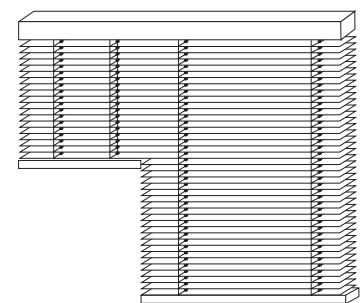

CUT OUTS

### CUT OUTS

Allows access to air conditioners, window cranks, etc. Side cutouts are available. A diagram may be required. Not available with cordless control.

Hardwood and Variance™ Faux Wood Finish Index

	2½" HARDWOOD	2" HARDWOOD	1" HARDWOOD	2" VARIANCE™
Americana Pine	52578082	52078082	51078082	52067405
Authentic Cherry		520MS007		
Basic Black		52002884*		
Black Walnut		520DS005		
Brilliant White	52502321	52002321	51002321	52067100
Brown Ash		520LS002		
Buckeye	525DS001	520DS001	510DS001	520DS007
Burnt Cinnamon		52081342		
Caramel Oak		520MS005		
Cherry Sangria	525MS001	520MS001	510MS001	520MS009
China	52502908	52002908*	51002908	52067130*
Cognac		52081338*		
Colonial Oak	52502771	52002771	51002771	52067217
Dark Roast		52081340		
English Grey		520MS004		
European Maple		520LS005		
Gray Embers		520DS002		
Heirloom Autumn		52002897		
Heirloom Ivory		520WH001		
Heirloom Oak	52502888	52002888	51002888	
High Gloss Colonial Oak		52002352		
Light Cherry		52081337		
Natural Grain		52002798		
Natural Pine		520LS008		
Oil Rubbed		520MS003		
Oldspice		52081341		
Pale Ivory		52078027		52067200*
Persian Walnut		52002772*		
Porcelain	52581019	52081019	51081019	52067160*
Pure Maple		520LS006		
Rich Mahogany	525DS003	520DS003	510DS003	520DS008
Rustic Hardwood		520DS004		
Rustic Natural		520LS007		
Sandblasted China		52002909		52067265
Sandblasted Porcelain		52081089		52067371
Sandblasted Swiss Chocolate		520NU002		520NU006
Silk		520WH002		520WH003*
Smoked Hickory	52578097	52078097	51078097	52067410
Summer Oak		520MS006		
Swiss Chocolate		520NU001*		520NU005*
Warm Chestnut	52502777	52002777	51002777	52067404
White Ash		520LS003		

\*Available in Classique™ Value style package.

Resemblance™ Faux Wood Finish Index

	2½" RESEMBLANCE™	2" RESEMBLANCE™
Antique White		520WH004
Bright White		52067109*
Café	525DT001	520DT001*
Caribbean Sands	525NU004	520NU004
Chocolate	52567504	52067504
Crème	52567102	52067102*
Rich Pine	52567505	52067505
Royal Oak		52067500*
Sandblasted Bright White		52067108*
Sandblasted Caribbean Sands	52567403	52067403
Sandblasted Traditional White	52567110	52067110
Strawberry Blonde		520NU003
Toasted Pecan	52567501	52067501
Traditional White	52567101	52067101
Vineyard		52067503

\*Available in Classique™ Value style package.

DECORATIVE TAPES COLOR INDEX









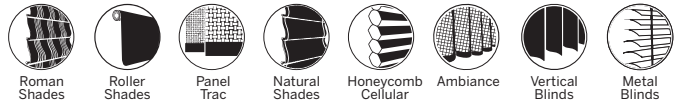

















































PATTERN—½" WIDE		SOLID—½" AND 1½" WIDE	
Coffee Leaves	BR005	Autumn	00301
Flora Cappuccino	BR003	Beach	00352
Flora Powder	WH006	Blossom	WH005
Glacier Ribbon	01201	Chapel	70802
Modern Filigree Flax	BR002	Coffee	00378
Modern Filigree Stone	NU008	Flax	00138
Nautical Stripe Flax	01237	Merlot	00755
Threaded Flax	BR004	Midnight	00890
		Pesto	00504
		Poupon	00162
		Powder	00140
		Pure	00110
		Smoke	GY002
		Steam	GY003



# Color Coordination Reference Guide

Kirsch Hardwood, Faux Wood Blinds and decorative tapes feature a wide assortment of colors that coordinate with other Kirsch window treatments—represented by the icons in our reference guide.



DECORATIVE TAPES		TAPE TO EDGE BINDING COORDINATION	TAPE TO BLIND OR SHADE COORDINATION	RESEMBLANCE™ FAUX WOOD	COORDINATION
PATTERN — 1½" WIDE	Coffee Leaves			Antique White	
	Flora Cappuccino			Bright White	
	Flora Powder			Café	
	Glacier Ribbon			Caribbean Sands	
	Modern Filigree Flax		 	Chocolate	
	Modern Filigree Stone		 	Crème	
	Nautical Stripe Flax			Rich Pine	
	Threaded Flax			Royal Oak	
SOLID — ½" & 1½" WIDE	Autumn			Sandblasted Bright White	
	Beach			Sandblasted Caribbean Sands	
	Blossom			Sandblasted Traditional White	
	Chapel		   	Strawberry Blonde	
	Coffee		      	Toasted Pecan	
	Flax		  	Traditional White	
	Merlot			Vineyard	
	Midnight		       		
	Pesto		  		
	Poupon				
	Powder		      		
	Pure		      		
	Smoke				
	Steam				

## Cornices

### FEATURES AND BENEFITS

- Crafted from premium hardwoods
- Seven fine furniture quality finishes available
- Two distinct profiles, Traditional and Modern to complement any home décor
- Corners are mitered
- Dust cover available on outside mount

### PROFILES

**TRADITIONAL  
(ROPE DESIGN)  
4.5" HIGH**



**MODERN  
(DENTIL DESIGN)  
4.5" HIGH**



### CORNICE FINISHES

AVAILABLE FINISHES						
Warm Chestnut 1002777	Colonial Oak 1002771	Natural Grain 1002798	China 1002908	Porcelain 1081019	Smoked Hickory 1078097	Unfinished 10098

### HOW TO MEASURE

**NOTE: All cornice measurements are made on the inside (non decorative) face as shown at right.**

#### INSIDE MOUNT (IM) INSTALLATION

Inside Width: Measure width of opening to the nearest 1/8". We recommend deducting 1/8" from width to ensure clearance. Factory takes no deductions or additions.

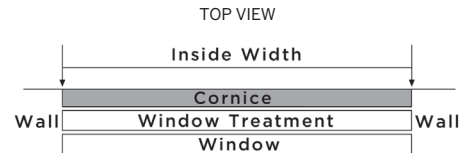

**Inside Mount (top view)**

#### OUTSIDE MOUNT (OM) INSTALLATION

Inside Width: Measure width to be covered to the nearest 1/8". We recommend adding 1 1/2" (3/4" clearance for each side) to cover the widest dimension of any obstruction such as moldings, window treatments including hardware, or draperies. Specify return length. Factory takes no deductions or additions.

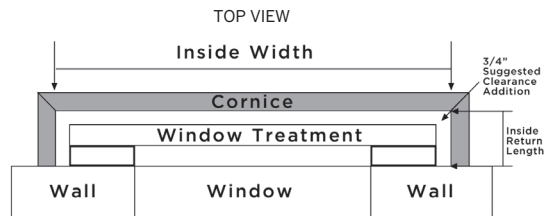

**Outside Mount (top view)**

#### INSIDE RETURN LENGTH

Measure length to be covered to the nearest 1/8". We recommend adding 3/4" for additional clearance to cover any obstruction such as moldings, window treatments including hardware or draperies. Factory takes no deductions or additions.

### MINIMUMS AND MAXIMUMS

Profile Thickness 1"

	MIN.	MAX.
Inside Width	6 5/8"	118"
Outside Width	7 5/8"	119"
Inside Return Length	1 1/2"	7 1/2"

**NOTE:** Factory makes no deductions or additions.

## Cornice Pricing

	WIDTH UP TO				
	36"	54"	72"	90"	118"
Inside Mount Finished	210	312	452	549	727
Inside Mount Unfinished	202	305	444	542	719
Outside Mount Finished	296	436	635	770	1,017
Outside Mount Unfinished	288	428	627	762	1,010

## MOUNTING OPTIONS

### OUTSIDE MOUNT

MOUNT CODE	DUSTCOVER OPTION	INSIDE RETURN LENGTH OPTION	BRACKET TYPE	APPLICATION
A	Standard	2 <sup>5</sup> / <sub>8</sub> "	Slotted Bracket	Kirsch 2" Wood blinds only
B	Standard	4 <sup>1</sup> / <sub>2</sub> "	Slotted Bracket	Common Over Verticals
C	Standard	6"	Slotted Bracket	Common Over Verticals
D	Standard	Any Length: Min 1 <sup>1</sup> / <sub>2</sub> " Max 7 <sup>1</sup> / <sub>2</sub> "	Slotted Bracket	Any
E	N/A	Any Length: Min 3 <sup>3</sup> / <sub>4</sub> " Max 5 <sup>1</sup> / <sub>2</sub> "	Adjustable Short Bracket	Any
F	N/A	Any Length: Min 5 <sup>1</sup> / <sub>2</sub> " Max 7 <sup>1</sup> / <sub>2</sub> "	Adjustable Long Bracket	Any
G	N/A	2 <sup>5</sup> / <sub>8</sub> "	Clip-on	Kirsch 2" blinds only

### INSIDE MOUNT

MOUNT CODE	BRACKET TYPE	APPLICATION
H	Clip-on	Kirsch 2" blinds only
I	Slotted Bracket	Any

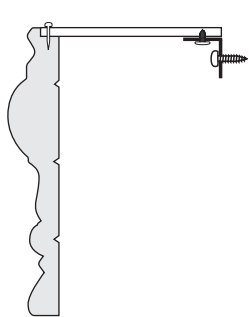

OPTION A-D

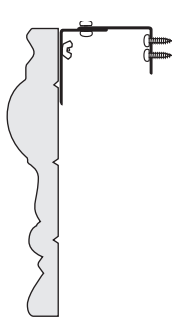

OPTION E-F

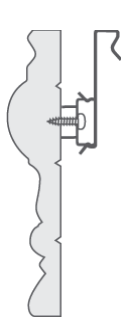

OPTION G-H

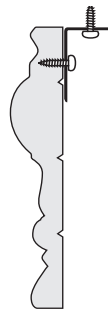

OPTION I

# Price Group A— 2" Resemblance™ Classique™ Value Faux Wood Blinds

## AVAILABLE FINISHES

52067109 Bright White	52067500 Royal Oak
520DT001 Café	52067108 Sandblasted Bright White
52067102 Crème	

## AVAILABLE DECORATIVE TAPES

### 1½" And ½" Solid Fabrics

00301 Autumn	00138 Flax	00140 Powder
00352 Beach	00755 Merlot	00110 Pure
WH005 Blossom	00890 Midnight	GY002 Smoke
70802 Chapel	00504 Pesto	GY003 Steam
00378 Coffee	00162 Poupon	

## AVAILABLE DECORATIVE TAPES

### 1½" Pattern Fabrics

BR005 Coffee Leaves	01201 Glacier Ribbon	01237 Nautical Flax Stripe
BR003 Flora Cappuccino	BR002 Modern Filigree Flax	BR004 Threaded Flax
WH006 Flora Powder	NU008 Modern Filigree Stone	

## PRODUCT SPECIFICATIONS

### Ladder Spacing and Cord Count Charts

BLIND WIDTH				# OF LADDERS	# OF LIFT CORDS ON CORDED BLIND	# OF CORDS WITH CORDED PRIVACY
INSIDE MOUNT MINIMUM	INSIDE MOUNT MAXIMUM	OUTSIDE MOUNT MINIMUM	OUTSIDE MOUNT MAXIMUM			
7¾"	19½"	7¼"	19"	2	2	4
19⅝"	31½"	19⅛"	31"	3	2	4
31⅝"	43½"	31⅛"	43"	4	4	8
43⅝"	55½"	43⅛"	55"	5	3	6
55⅝"	67½"	55⅛"	67"	6	4	8
67⅝"	79½"	67⅛"	79"	7	4	8
79⅝"	96½"	79⅛"	96"	8	4	8

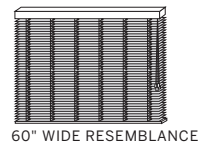

### Single Blind Minimum and Maximum Limitations

	MINIMUM WIDTH	MAXIMUM WIDTH	MINIMUM HEIGHT	MAXIMUM HEIGHT
Corded - Opposite Side Lift controls without Tapes	11½"	96"	10"	120"
Corded - Opposite Side Lift controls with Tapes	13¼"	96"	10"	120"
Center Tilt, No Lift Control without Tapes	9"	11⅜"	8"	120"
Center Tilt, No Lift Control with Tapes	9"	13⅛"	8"	120"
No Tilt or Lift Control with or without Tapes	7¼"	8⅞"	8"	120"

See price grids for more details.



### Stacking Chart—Height Includes Headrail

BLIND HEIGHT	24"	36"	42"	48"	54"	60"	66"	72"	84"	96"	108"	120"
2" Slats	3¾"	4½"	5"	5½"	5¾"	6¼"	6½"	6¾"	7½"	8¼"	9"	10"

Stacking dimensions are approximate.

# Price Group A– 2" Resemblance™ Classique™ Value Faux Wood Blinds

Finishes available: Crème, Royal Oak, Bright White, Sandblasted Bright White, Café

PRICE GROUP A																		
	16"	23"	31"	36"	42"	48"	54"	60"	66"	72"	78"	84"	90"	96"	108"	120"	132"	144"
Height to 30"	104	115	158	197	224	263	297	342	366	394	431	456	492	528	581	634	687	740
36"	139	151	193	228	259	282	329	383	419	447	475	504	528	565	622	679	736	792
42"	151	162	205	239	278	324	363	419	450	463	504	557	590	626	696	764	833	903
48"	158	178	224	259	305	352	390	467	499	564	594	606	667	703	777	850	922	996
54"	182	197	248	282	340	383	433	515	564	616	675	699	740	785	866	947	1029	1110
60"	197	216	264	317	359	413	479	551	596	668	728	785	805	858	947	1037	1126	1216
66"	212	228	272	340	390	444	529	628	676	708	801	841	907	971	1073	1175	1277	1378
72"	232	251	302	359	428	483	568	644	721	801	841	911	996	1037	1146	1256	1367	1476
78"	255	275	336	417	475	529	606	700	777	854	911	996	1082	1179	1301	1423	1545	1667
84"	278	302	379	454	515	600	680	760	870	956	996	1057	1163	1289	1423	1557	1691	1825
90"	313	334	402	475	565	634	732	809	886	971	1049	1126	1236	1362	1505	1646	1789	1931
96"	313	354	423	500	594	671	769	854	935	1041	1086	1184	1297	1427	1574	1720	1866	2012
102"	345	370	443	509	602	692	801	886	1009	1090	1154	1248	1362	1476	1631	1785	1940	2094
108"	347	390	472	549	651	736	866	922	1065	1146	1236	1322	1427	1516	1675	1834	1993	2151
114"	359	411	500	569	683	752	890	971	1130	1199	1273	1374	1484	1602	1769	1935		
120"	374	426	524	598	707	788	931	1000	1203	1252	1309	1448	1565	1675	1846	2017		
	single blind					2 blinds on one headrail							3 blinds on one headrail				Not available	
LightMaster™	32	36	41	45	53	61	69	77	85	94	106	113	118	122	130	158	175	187
Decorative Tapes (Solid)	21	24	28	28	36	41	45	53	57	61	69	73	77	81	89	106	118	126
Decorative Tapes (Pattern)	41	49	53	61	69	81	94	106	113	126	138	151	158	162	175	215	232	248

The maximum slat width is 96".

Shaded area requires multiple blinds per headrail. To price multiple blinds on a headrail, see price above based on overall width then add appropriate surcharge from below.

### FREE OPTIONS

Must be requested at time of order.

Choice of Control Options:

Tilter Left, Lift Cord Right (Standard)

Tilter Right, Lift Cord Left

Choice of Style Package:

Classic Value (Standard)

Choice of Tilting Control on Corded:

Cord

Wand

Extension Brackets (2" or 4")

Extended Valance (Up to 3" greater than ordered width)

Hold-down Brackets

### SURCHARGE OPTIONS

Cutouts:

Side Cutout

Surcharges

\$57 per side

Decorative Tapes:

½" Solid

1½" Solid

1½" Pattern

See Grid For Price

See Grid For Price

See Grid For Price

Extended Valance

(3" and greater beyond order width)

\$41

LightMaster™

See Grid For Price

Multiple Blinds on One Headrail:

2 Blinds per Headrail

3 Blinds per Headrail

\$85

\$110

Replacement Slat

\$7

Replacement Valance

\$41

## Price Group B—2" Resemblance™ Faux Wood Blinds

### AVAILABLE FINISHES

52067109 Bright White	52067108 Sandblasted Bright White	52067101 Traditional White
520NU004 Caribbean Sands	52067403 Sandblasted Caribbean Sands	
52067102 Crème	52067110 Sandblasted Traditional White	

### AVAILABLE DECORATIVE TAPES

#### 1½" And ½" Solid Fabrics

00301 Autumn	00138 Flax	00140 Powder
00352 Beach	00755 Merlot	00110 Pure
WH005 Blossom	00890 Midnight	GY002 Smoke
70802 Chapel	00504 Pesto	GY003 Steam
00378 Coffee	00162 Poupon	

### AVAILABLE DECORATIVE TAPES

#### 1½" Pattern Fabrics

BR005 Coffee Leaves	01201 Glacier Ribbon	01237 Nautical Flax Stripe
BR003 Flora Cappuccino	BR002 Modern Filigree Flax	BR004 Threaded Flax
WH006 Flora Powder	NU008 Modern Filigree Stone	

## PRODUCT SPECIFICATIONS

### Ladder Spacing and Cord Count Charts

#### BLIND WIDTH

INSIDE MOUNT MINIMUM	INSIDE MOUNT MAXIMUM	OUTSIDE MOUNT MINIMUM	OUTSIDE MOUNT MAXIMUM	# OF TAPES OR LADDERS	# OF LIFT CORDS ON CORDED BLIND	# OF CORDS WITH CORDED PRIVACY
7 ¾"	19 ½"	7 ¼"	19"	2	2	4
19 ⅝"	31 ½"	19 ⅛"	31"	3	2	4
31 ⅝"	43 ½"	31 ⅛"	43"	4	4	8
43 ⅝"	55 ½"	43 ⅛"	55"	5	3	6
55 ⅝"	67 ½"	55 ⅛"	67"	6	4	8
67 ⅝"	79 ½"	67 ⅛"	79"	7	4	8
79 ⅝"	96 ½"	79 ⅛"	96"	8	4	8

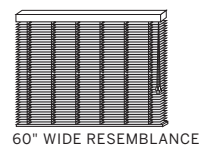

### Single Blind Minimum and Maximum Limitations

	MINIMUM WIDTH	MAXIMUM WIDTH	MINIMUM HEIGHT	MAXIMUM HEIGHT
Corded—Opposite Side Lift Controls without Tapes	11½"	96"	10"	120"
Corded—Opposite Side Lift Controls with Tapes	13¼"	96"	10"	120"
Center Tilt, No Lift Control without Tapes	9"	11⅜"	8"	120"
Center Tilt, No Lift Control with Tapes	9"	13⅜"	8"	120"
No Tilt or Lift Control with or without Tapes	7¼"	8⅞"	8"	120"
Cordless with or without Tapes	12½"	72"	10"	72"

See price grids for more details.



### Stacking Chart—Height Includes Headrail

BLIND HEIGHT	24"	36"	42"	48"	54"	60"	66"	72"	84"	96"	108"	120"
2" Slats	3¾"	4½"	5"	5½"	5¾"	6¼"	6½"	6¾"	7½"	8¼"	9"	10"

Stacking dimensions are approximate.

## Price Group B—2" Resemblance™ Faux Wood Blinds

**Finishes available:** Traditional White, Sandblasted Traditional White, Sandblasted Caribbean Sand, Caribbean Sand, Crème, Bright White, Sandblasted Bright White

PRICE GROUP B																			
	Width to																		
	16"	23"	31"	36"	42"	48"	54"	60"	66"	72"	78"	84"	90"	96"	108"	120"	132"	144"	
Height to 30"	110	122	166	207	236	277	313	345	370	398	431	456	492	528	581	634	687	740	
36"	147	158	203	240	272	296	345	386	423	451	475	504	528	565	622	679	736	792	
42"	158	171	215	252	292	341	382	423	456	468	504	557	590	626	696	764	833	903	
48"	166	187	236	272	321	370	411	472	504	569	594	606	667	703	777	850	922	996	
54"	191	207	260	296	358	402	456	520	569	622	675	699	740	785	866	947	1029	1110	
60"	207	228	272	334	379	435	504	557	602	675	728	785	805	858	947	1037	1126	1216	
Cordless 66"	224	240	277	358	411	468	557	634	683	716	801	841	907	971	1073	1175	1277	1378	
available up to 72"	244	264	317	379	451	509	598	651	728	801	841	911	996	1037	1146	1256	1367	1476	
78"	268	289	354	439	500	557	639	707	777	854	911	996	1082	1179	1301	1423	1545	1667	
84"	281	305	382	460	520	606	687	760	870	956	996	1057	1163	1289	1423	1557	1691	1825	
90"	313	334	402	475	565	634	732	809	886	971	1049	1126	1236	1362	1505	1646	1789	1931	
96"	330	354	423	500	594	671	769	854	935	1041	1086	1184	1297	1427	1574	1720	1866	2012	
102"	345	370	443	509	602	692	801	886	1009	1090	1154	1248	1362	1476	1631	1785	1940	2094	
108"	366	390	472	549	651	736	866	922	1065	1146	1236	1322	1427	1516	1675	1834	1993	2151	
114"	379	411	500	569	683	752	890	971	1130	1199	1273	1374	1484	1602	1769	1935			
120"	394	426	524	598	707	788	931	1000	1203	1252	1309	1448	1565	1675	1846	2017			
	single blind					2 blinds on one headrail							3 blinds on one headrail					Not available	
Cordless	285					569							569						
LightMaster™	32	36	41	45	53	61	69	77	85	94	106	113	118	122	130	158	175	187	
Decorative Tapes (Solid)	21	24	28	28	36	41	45	53	57	61	69	73	77	81	89	106	118	126	
Decorative Tapes (Pattern)	41	49	53	61	69	81	94	106	113	126	138	151	158	162	175	215	232	248	

The maximum slat width is 96".

Cordless upgrade maximum height is 72". If width is greater than 72", it requires two blinds on one headrail.

Shaded area requires multiple blinds per headrail. To price multiple blinds on a headrail, see price above based on overall width then add appropriate surcharge from below.

FREE OPTIONS
Must be requested at time of order.
Choice of Control Options: Tilter Left, Lift Cord Right (Standard) Tilter Right, Lift Cord Left
Choice of Style Package: Traditional (Standard) Contemporary (Optional)
Choice of Tilting Control on Corded: Cord (Not offered on Cordless) Wand
Extension Brackets (2" or 4")
Extended Valance (Up to 3" greater than ordered width)
Hold-down Brackets

SURCHARGE OPTIONS	
Cordless:	Surcharges
1 Blind per Headrail	\$285
2 or 3 Blinds per Headrail	\$569
Cutouts (corded only):	
Side Cutout	\$57 per side
Decorative Tapes:	
½" Solid	See Grid For Price
1½" Solid	See Grid For Price
1½" Pattern	See Grid For Price
Extended Valance (3" and greater beyond order width)	\$41
LightMaster™	See Grid For Price
Multiple Blinds on One Headrail:	
2 Blinds per Headrail	\$85
3 Blinds per Headrail	\$110
Replacement Slat	\$7
Replacement Valance	\$41

## Price Group C—2½" Resemblance™ Faux Wood Blinds

### AVAILABLE FINISHES

525NU004 Caribbean Sands	52567110 Sandblasted Traditional White
52567102 Crème	52567101 Traditional White
52567403 Sandblasted Caribbean Sands	

### AVAILABLE DECORATIVE TAPES

#### 1½" And ½" Solid Fabrics

00301 Autumn	00138 Flax	00140 Powder
00352 Beach	00755 Merlot	00110 Pure
WH005 Blossom	00890 Midnight	GY002 Smoke
70802 Chapel	00504 Pesto	GY003 Steam
00378 Coffee	00162 Poupon	

### AVAILABLE DECORATIVE TAPES

#### 1½" Pattern Fabrics

BR005 Coffee Leaves	01201 Glacier Ribbon	01237 Nautical Flax Stripe
BR003 Flora Cappuccino	BR002 Modern Filigree Flax	BR004 Threaded Flax
WH006 Flora Powder	NU008 Modern Filigree Stone	

## PRODUCT SPECIFICATIONS

### Ladder Spacing and Cord Count Charts

BLIND WIDTH				# OF TAPES OR LADDERS	# OF LIFT CORDS ON CORDED BLIND	# OF CORDS WITH CORDED PRIVACY
INSIDE MOUNT MINIMUM	INSIDE MOUNT MAXIMUM	OUTSIDE MOUNT MINIMUM	OUTSIDE MOUNT MAXIMUM			
7¾"	19½"	7¼"	19"	2	2	4
19⅝"	31½"	19⅛"	31"	3	2	4
31⅝"	43½"	31⅛"	43"	4	4	8
43⅝"	55½"	43⅛"	55"	5	3	6
55⅝"	67½"	55⅛"	67"	6	4	8
67⅝"	79½"	67⅛"	79"	7	4	8
79⅝"	96½"	79⅛"	96"	8	4	8

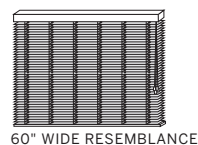

### Single Blind Minimum and Maximum Limitations

	MINIMUM WIDTH	MAXIMUM WIDTH	MINIMUM HEIGHT	MAXIMUM HEIGHT
Corded—Opposite Side Lift Controls without Tapes	11½"	96"	10"	120"
Corded—Opposite Side Lift Controls with Tapes	13¼"	96"	10"	120"
Center Tilt, No Lift Control without Tapes	9"	11⅜"	8"	120"
Center Tilt, No Lift Control with Tapes	9"	13⅜"	8"	120"
No Tilt or Lift Control with or without Tapes	7¼"	8⅞"	8"	120"
Cordless with or without Tapes	12½"	72"	10"	72"

See price grids for more details.



### Stacking Chart—Height Includes Headrail

BLIND HEIGHT	24"	36"	42"	48"	54"	60"	66"	72"	84"	96"	108"	120"
2½" Slats	3½"	4"	4½"	4¾"	5"	5¼"	5½"	6"	6½"	7"	7¾"	8¼"

Stacking dimensions are approximate.



# Price Group C—2½" Resemblance™ Faux Wood Blinds

**Finishes available:** Traditional White, Sandblasted Traditional White, Sandblasted Carribean Sand, Caribbean Sand, Crème

PRICE GROUP C																		
	Width to																	
	16"	23"	31"	36"	42"	48"	54"	60"	66"	72"	78"	84"	90"	96"	108"	120"	132"	144"
Height to 30"	122	142	191	236	264	317	349	386	423	451	488	513	549	602	667	732	797	862
36"	162	183	232	268	313	341	386	439	472	509	537	569	602	639	707	777	846	915
42"	183	196	244	281	337	382	435	472	513	528	569	626	667	707	785	862	939	1016
48"	191	207	264	313	358	423	464	532	569	643	671	687	752	797	882	967	1054	1139
54"	219	236	292	341	407	456	513	590	643	703	760	792	841	882	976	1069	1163	1256
60"	236	256	309	374	431	492	569	626	683	760	822	882	911	967	1069	1171	1273	1374
Cordless 66" available up to 72"	252	268	317	407	464	528	626	720	756	809	907	952	1029	1098	1212	1326	1439	1553
78"	309	334	398	496	565	626	724	801	878	964	1033	1126	1224	1333	1472	1610	1748	1887
84"	321	345	435	520	590	687	773	858	984	1077	1126	1195	1314	1452	1602	1752	1903	2053
90"	349	374	456	537	639	720	830	915	1000	1098	1184	1273	1399	1541	1699	1858	2017	2176
96"	370	398	472	565	671	756	870	964	1054	1175	1228	1337	1463	1610	1776	1944	2110	2277
102"	386	423	500	577	683	777	907	1000	1146	1232	1305	1415	1541	1667	1838	2008	2179	2350
108"	419	447	532	618	736	833	976	1045	1203	1297	1399	1492	1610	1712	1887	2061	2236	2411
114"	431	464	565	643	769	850	1005	1098	1277	1350	1435	1553	1691	1814	2004	2195		
120"	447	475	594	679	801	886	1049	1135	1354	1419	1476	1642	1769	1891	2089	2289		
	single blind					2 blinds on one headrail						3 blinds on one headrail						Not available
Cordless	285					569						569						
LightMaster™	32	36	41	45	53	61	69	77	85	94	106	113	118	122	130	158	175	187
Decorative Tapes (Solid)	24	30	37	38	50	56	62	72	78	84	93	100	106	112	129	146	163	180
Decorative Tapes (Pattern)	52	63	72	82	97	112	127	145	155	173	184	202	214	224	252	295	324	357

The maximum slat width is 96".

Cordless upgrade maximum height is 72". If width is greater than 72", it requires two blinds on one headrail.

Shaded area requires multiple blinds per headrail. To price multiple blinds on a headrail, see price above based on overall width then add appropriate surcharge from below.

FREE OPTIONS
Must be requested at time of order.
Choice of Control Options: Tilter Left, Lift Cord Right (Standard) Tilter Right, Lift Cord Left
Choice of Style Package: Traditional (Standard) Contemporary (Optional)
Choice of Tilting Control on Corded: Cord (Not offered on Cordless) Wand
Extension Brackets (2" or 4")
Extended Valance (Up to 3" greater than ordered width)
Hold-down Brackets

SURCHARGE OPTIONS	
Cordless:	Surcharges
1 Blind per Headrail	\$285
2 or 3 Blinds per Headrail	\$569
Cutouts (corded only):	
Side Cutout	\$57 per side
Decorative Tapes:	
½" Solid	See Grid For Price
1½" Solid	See Grid For Price
1½" Pattern	See Grid For Price
Extended Valance (3" and greater beyond order width)	\$45
LightMaster™	See Grid For Price
Multiple Blinds on One Headrail:	
2 Blinds per Headrail	\$98
3 Blinds per Headrail	\$126
Replacement Slat	\$7
Replacement Valance	\$45

## Price Group D– 2" Resemblance™ Faux Wood Blinds

### AVAILABLE FINISHES

520WH004 Antique White	52067505 Rich Pine	52067501 Toasted Pecan
520DT001 Café	52067500 Royal Oak	52067503 Vineyard
52067504 Chocolate	520NU003 Strawberry Blonde	

### AVAILABLE DECORATIVE TAPES

#### 1½" And ½" Solid Fabrics

00301 Autumn	00138 Flax	00140 Powder
00352 Beach	00755 Merlot	00110 Pure
WH005 Blossom	00890 Midnight	GY002 Smoke
70802 Chapel	00504 Pesto	GY003 Steam
00378 Coffee	00162 Poupon	

### AVAILABLE DECORATIVE TAPES

#### 1½" Pattern Fabrics

BR005 Coffee Leaves	01201 Glacier Ribbon	01237 Nautical Flax Stripe
BR003 Flora Cappuccino	BR002 Modern Filigree Flax	BR004 Threaded Flax
WH006 Flora Powder	NU008 Modern Filigree Stone	

## PRODUCT SPECIFICATIONS

### Ladder Spacing and Cord Count Charts

BLIND WIDTH				# OF TAPES OR LADDERS	# OF LIFT CORDS ON CORDED BLIND	# OF CORDS WITH CORDED PRIVACY
INSIDE MOUNT MINIMUM	INSIDE MOUNT MAXIMUM	OUTSIDE MOUNT MINIMUM	OUTSIDE MOUNT MAXIMUM			
7¾"	19½"	7¼"	19"	2	2	4
19⅝"	31½"	19⅛"	31"	3	2	4
31⅝"	43½"	31⅛"	43"	4	4	8
43⅝"	55½"	43⅛"	55"	5	3	6
55⅝"	67½"	55⅛"	67"	6	4	8
67⅝"	79½"	67⅛"	79"	7	4	8
79⅝"	96½"	79⅛"	96"	8	4	8

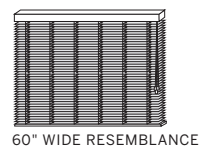

### Single Blind Minimum and Maximum Limitations

	MINIMUM WIDTH	MAXIMUM WIDTH	MINIMUM HEIGHT	MAXIMUM HEIGHT
Corded—Opposite Side Lift Controls without Tapes	11½"	96"	10"	120"
Corded—Opposite Side Lift Controls with Tapes	13¼"	96"	10"	120"
Center Tilt, No Lift Control without Tapes	9"	11⅜"	8"	120"
Center Tilt, No Lift Control with Tapes	9"	13⅜"	8"	120"
No Tilt or Lift Control with or without Tapes	7¼"	8⅞"	8"	120"
Cordless with or without Tapes	12½"	72"	10"	72"

See price grids for more details.



### Stacking Chart—Height Includes Headrail

BLIND HEIGHT	24"	36"	42"	48"	54"	60"	66"	72"	84"	96"	108"	120"
2" Slats	3¾"	4½"	5"	5½"	5¾"	6¼"	6½"	6¾"	7½"	8¼"	9"	10"

Stacking dimensions are approximate.

# Price Group D—2" Resemblance™ Faux Wood Blinds

Finishes available: Chocolate, Rich Pine, Toasted Pecan, Royal Oak, Strawberry Blonde, Café, Antique White

PRICE GROUP D																		
	Width to																	
	16"	23"	31"	36"	42"	48"	54"	60"	66"	72"	78"	84"	90"	96"	108"	120"	132"	144"
Height to 30"	130	142	191	240	264	321	354	390	426	456	492	517	562	606	671	736	801	866
36"	166	183	232	272	317	345	390	443	475	513	545	577	606	643	711	781	850	919
42"	183	196	248	285	337	386	439	475	517	532	577	634	675	716	792	870	947	1024
48"	191	211	264	317	362	426	468	537	577	647	679	692	756	801	886	971	1057	1143
54"	219	240	292	345	407	460	517	598	647	711	764	797	850	890	984	1077	1171	1265
60"	240	256	317	379	435	496	577	647	687	764	830	890	915	976	1077	1179	1280	1382
Cordless 66"	252	272	321	407	468	532	634	724	777	817	911	960	1037	1110	1228	1346	1463	1582
available up to 72"	277	296	358	435	509	581	683	744	830	911	960	1041	1139	1179	1301	1423	1545	1667
78"	313	334	402	500	569	634	728	805	886	971	1041	1139	1232	1342	1480	1618	1757	1895
84"	326	349	439	524	598	692	785	866	992	1086	1139	1203	1326	1467	1618	1769	1919	2070
90"	354	379	460	545	643	724	833	922	1009	1110	1195	1289	1411	1557	1720	1882	2045	2208
96"	374	402	475	569	679	760	875	971	1065	1184	1236	1350	1476	1627	1793	1959	2127	2293
102"	394	426	504	581	687	788	911	1009	1154	1244	1318	1427	1557	1684	1858	2033	2208	2383
108"	423	447	537	622	744	841	984	1054	1216	1305	1411	1508	1627	1728	1910	2094	2277	2460
114"	435	468	569	647	777	858	1016	1110	1293	1362	1448	1569	1691	1829	2021	2212		
120"	451	479	602	683	797	894	1057	1146	1371	1431	1488	1655	1785	1910	2110	2310		
	single blind					2 blinds on one headrail							3 blinds on one headrail				Not available	
Cordless	285					569							569					
LightMaster™	32	36	41	45	53	61	69	77	85	94	106	113	118	122	130	158	175	187
Decorative Tapes (Solid)	21	24	28	28	36	41	45	53	57	61	69	73	77	81	89	106	118	126
Decorative Tapes (Pattern)	41	49	53	61	69	81	94	106	113	126	138	151	158	162	175	215	232	248

The maximum slat width is 96".

Cordless upgrade maximum height is 72". If width is greater than 72", it requires two blinds on one headrail.

Shaded area requires multiple blinds per headrail. To price multiple blinds on a headrail, see price above based on overall width then add appropriate surcharge from below.

FREE OPTIONS
Must be requested at time of order.
Choice of Control Options: Tilter Left, Lift Cord Right (Standard) Tilter Right, Lift Cord Left
Choice of Style Package: Traditional (Standard) Contemporary (Optional)
Choice of Tilting Control on Corded: Cord (Not offered on Cordless) Wand
Extension Brackets (2" or 4")
Extended Valance (Up to 3" greater than ordered width)
Hold-down Brackets

SURCHARGE OPTIONS	
Cordless:	Surcharges
1 Blind per Headrail	\$285
2 or 3 Blinds per Headrail	\$569
Cutouts (corded only):	
Side Cutout	\$57 per side
Decorative Tapes:	
1/2" Solid	See Grid For Price
1 1/2" Solid	See Grid For Price
1 1/2" Pattern	See Grid For Price
Extended Valance (3" and greater beyond order width)	\$41
LightMaster™	See Grid For Price
Multiple Blinds on One Headrail:	
2 Blinds per Headrail	\$85
3 Blinds per Headrail	\$110
Replacement Slat	\$7
Replacement Valance	\$41

# Price Group E-2" Classique™ Value Variance Faux Wood Blinds

## AVAILABLE FINISHES

52002908 China	520WH003 Silk
52067200 Pale Ivory	520NU005 Swiss Chocolate
52067160 Porcelain	

## AVAILABLE DECORATIVE TAPES

### 1½" And ½" Solid Fabrics

00301 Autumn	00138 Flax	00140 Powder
00352 Beach	00755 Merlot	00110 Pure
WH005 Blossom	00890 Midnight	GY002 Smoke
70802 Chapel	00504 Pesto	GY003 Steam
00378 Coffee	00162 Poupon	

## AVAILABLE DECORATIVE TAPES

### 1½" Pattern Fabrics

BR005 Coffee Leaves	01201 Glacier Ribbon	01237 Nautical Flax Stripe
BR003 Flora Cappuccino	BR002 Modern Filigree Flax	BR004 Threaded Flax
WH006 Flora Powder	NU008 Modern Filigree Stone	

## PRODUCT SPECIFICATIONS

### Ladder Spacing and Cord Count Charts

BLIND WIDTH				# OF TAPES OR LADDERS	# OF LIFT CORDS ON CORDED BLIND	# OF CORDS WITH CORDED PRIVACY
INSIDE MOUNT MINIMUM	INSIDE MOUNT MAXIMUM	OUTSIDE MOUNT MINIMUM	OUTSIDE MOUNT MAXIMUM			
7¾"	22"	7¼"	21½"	2	2	4
22⅛"	36½"	21⅝"	36"	3	2	4
36⅝"	51"	36⅞"	50½"	4	4	8
51⅞"	65½"	50⅝"	65"	5	3	6
65⅝"	80"	65⅞"	79½"	6	4	8
80⅞"	94½"	79⅝"	94"	7	4	8
94⅝"	96½"	94⅞"	96"	8	4	8

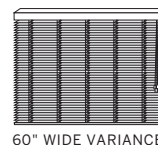

### Single Blind Minimum and Maximum Limitations

	MINIMUM WIDTH	MAXIMUM WIDTH	MINIMUM HEIGHT	MAXIMUM HEIGHT
Corded—Opposite Side Lift Controls without Tapes	11½"	96"	10"	120"
Corded—Opposite Side Lift Controls with Tapes	13¼"	96"	10"	120"
Center Tilt, No Lift Control without Tapes	9"	11⅜"	8"	120"
Center Tilt, No Lift Control with Tapes	9"	13⅜"	8"	120"
No Tilt or Lift Control with or without Tapes	7¼"	8⅞"	8"	120"

See price grids for more details.



### Stacking Chart—Height Includes Headrail

BLIND HEIGHT	24"	36"	42"	48"	54"	60"	66"	72"	84"	96"	108"	120"
2" Slats	3¾"	4½"	5"	5½"	5¾"	6¼"	6½"	6¾"	7½"	8¼"	9"	10"

Stacking dimensions are approximate.

# Price Group E—2" Classique™ Value Variance Faux Wood Blinds

Finishes available: China, Porcelain, Pale Ivory, Swiss Chocolate, Silk

PRICE GROUP E																		
Height to	Width to																	
	16"	23"	31"	36"	42"	48"	54"	60"	66"	72"	78"	84"	90"	96"	108"	120"	132"	144"
30"	163	179	226	262	278	294	350	411	419	422	541	651	679	724	797	870	943	1016
36"	179	196	237	294	334	370	435	467	508	540	622	752	797	854	943	1033	1122	1212
42"	205	226	278	330	374	402	491	531	592	636	692	833	915	971	1069	1167	1265	1362
48"	233	250	306	362	411	447	531	583	644	676	773	931	1033	1094	1207	1322	1435	1550
54"	258	269	334	398	447	499	592	648	712	764	862	1054	1126	1195	1318	1439	1561	1684
60"	282	298	366	431	499	564	644	725	789	861	956	1171	1252	1329	1472	1614	1757	1899
66"	314	322	387	462	560	620	708	797	861	942	1054	1289	1374	1472	1627	1780	1935	2089
72"	327	346	438	514	596	684	769	861	946	1037	1146	1390	1505	1614	1785	1955	2127	2297
78"	358	387	459	540	620	708	833	921	1033	1114	1240	1508	1631	1736	1919	2102	2285	2468
84"	390	419	508	583	676	764	882	971	1061	1171	1302	1635	1748	1874	2070	2265	2460	2655
90"	484	504	626	752	870	1000	1130	1260	1374	1505	1627	1752	1891	2012	2225	2436	2647	2858
96"	509	524	667	797	927	1069	1191	1350	1472	1610	1740	1887	2017	2163	2391	2619	2846	3074
102"	537	557	707	854	992	1135	1273	1431	1557	1712	1846	2000	2151	2289	2529	2768	3009	3249
108"	562	581	732	886	1033	1191	1329	1488	1642	1793	1935	2094	2248	2411	2663	2915	3168	3420
114"	590	610	769	931	1085	1251	1396	1562	1724	1882	2032	2199	2361	2531	2797	3061		
120"	618	639	805	976	1143	1318	1472	1627	1814	1972	2134	2310	2472	2655	2932	3208		
	single blind					2 blinds on one headrail						3 blinds on one headrail				Not available		
LightMaster™	36	49	61	69	85	98	110	126	134	147	158	171	183	196	236	256	289	330
Decorative Tapes (Solid)	24	32	41	45	57	66	73	81	89	98	106	113	122	130	158	171	191	219
Decorative Tapes (Pattern)	57	69	81	94	113	130	147	166	179	200	207	228	244	260	313	341	386	443

The maximum slat width is 96".

Shaded area requires multiple blinds per headrail. To price multiple blinds on a headrail, see price above based on overall width then add appropriate surcharge from below.

FREE OPTIONS
Must be requested at time of order.
Choice of Control Options: Tilter Left, Lift Cord Right (Standard) Tilter Right, Lift Cord Left
Style Package: Classique™ Value (Standard)
Tilting Control on Corded: Cord (Standard) Wand
Extension Brackets (2" or 4")
Extended Valance (Under 3")
Hold-down Brackets

SURCHARGE OPTIONS	
Cutouts: Side Cutout	Surcharges \$66 per side
Decorative Tapes: ½" Solid 1½" Solid 1½" Pattern	See Grid For Price See Grid For Price See Grid For Price
Extended Valance (3" and greater beyond order width)	\$45
LightMaster™	See Grid For Price
Multiple Blinds on One Headrail: 2 Blinds per Headrail 3 Blinds per Headrail	\$98 \$126
Replacement Slat	\$7
Replacement Valance	\$45

## Price Group F—2" Classique™ Value Hardwood Blinds

### AVAILABLE FINISHES

52002884 Basic Black	52002772 Persian Walnut
52002908 China	520NU001 Swiss Chocolate
52081338 Cognac	

### AVAILABLE DECORATIVE TAPES

#### 1½" And ½" Solid Fabrics

00301 Autumn	00138 Flax	00140 Powder
00352 Beach	00755 Merlot	00110 Pure
WH005 Blossom	00890 Midnight	GY002 Smoke
70802 Chapel	00504 Pesto	GY003 Steam
00378 Coffee	00162 Poupon	

### AVAILABLE DECORATIVE TAPES

#### 1½" Pattern Fabrics

BR005 Coffee Leaves	01201 Glacier Ribbon	01237 Nautical Flax Stripe
BR003 Flora Cappuccino	BR002 Modern Filigree Flax	BR004 Threaded Flax
WH006 Flora Powder	NU008 Modern Filigree Stone	

## PRODUCT SPECIFICATIONS

### Ladder Spacing and Cord Count Charts

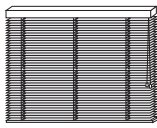
BLIND WIDTH				# OF TAPES OR LADDERS	# OF LIFT CORDS ON CORDED BLIND	# OF CORDS WITH CORDED PRIVACY	
INSIDE MOUNT MINIMUM	INSIDE MOUNT MAXIMUM	OUTSIDE MOUNT MINIMUM	OUTSIDE MOUNT MAXIMUM				
6½"	36½"	6"	36"	2	2	4	60" WIDE HARDWOOD
36⅝"	54½"	36⅝"	54"	3	2	4	
54⅝"	60½"	54⅝"	60"	3	3	6	
60⅝"	84½"	60⅝"	84"	4	4	8	
84⅝"	96½"	84⅝"	96"	5	3	6	

### Single Blind Minimum and Maximum Limitations

	MINIMUM WIDTH	MAXIMUM WIDTH	MINIMUM HEIGHT	MAXIMUM HEIGHT
Corded—Same Side Lift Controls with or without Tapes	20½"	96"	10"	120"
Corded—Opposite Side Lift Controls without Tapes	11½"	96"	10"	120"
Corded—Opposite Side Lift Controls with Tapes	13¼"	96"	10"	120"
Center Tilt, No Lift Control without Tapes	9"	11⅜"	8"	120"
Center Tilt, No Lift Control with Tapes	9"	13⅜"	8"	120"
No Tilt or Lift Control with or without Tapes	7¼"	8⅞"	8"	120"

See price grids for more details.



### Stacking Chart—Height Includes Headrail

BLIND HEIGHT	24"	36"	42"	48"	54"	60"	66"	72"	84"	96"	108"	120"
2" Slats	3¾"	4½"	5"	5½"	5¾"	6¼"	6½"	6¾"	7½"	8¼"	9"	10"

Stacking dimensions are approximate.

# Price Group F—2" Classique™ Value Hardwood Blinds

Finishes available: Cognac, Persian Walnut, Basic Black, China, Swiss Chocolate

PRICE GROUP F																		
	Width to																	
	16"	23"	31"	36"	42"	48"	54"	60"	66"	72"	78"	84"	90"	96"	108"	120"	132"	144"
Height to 30"	163	179	226	262	278	294	350	411	419	422	541	651	679	724	797	870	943	1016
36"	179	196	237	294	334	370	435	467	508	540	622	752	797	854	943	1033	1122	1212
42"	205	226	278	330	374	402	491	531	592	636	692	833	915	971	1069	1167	1265	1362
48"	233	250	306	362	411	447	531	583	644	676	773	931	1033	1094	1207	1322	1435	1550
54"	258	269	334	398	447	499	592	648	712	764	862	1054	1126	1195	1318	1439	1561	1684
60"	282	298	366	431	499	564	644	725	789	861	956	1171	1252	1329	1472	1614	1757	1899
66"	314	322	387	462	560	620	708	797	861	942	1054	1289	1374	1472	1627	1780	1935	2089
72"	327	346	438	514	596	684	769	861	946	1037	1146	1390	1505	1614	1785	1955	2127	2297
78"	358	387	459	540	620	708	833	921	1033	1114	1240	1508	1631	1736	1919	2102	2285	2468
84"	390	419	508	583	676	764	882	971	1061	1171	1302	1635	1748	1874	2070	2265	2460	2655
90"	484	504	626	752	870	1000	1130	1260	1374	1505	1627	1752	1891	2012	2225	2436	2647	2858
96"	509	524	667	797	927	1069	1191	1350	1472	1610	1740	1887	2017	2163	2391	2619	2846	3074
102"	537	557	707	854	992	1135	1273	1431	1557	1712	1846	2000	2151	2289	2529	2768	3009	3249
108"	562	581	732	886	1033	1191	1329	1488	1642	1793	1935	2094	2248	2411	2663	2915	3168	3420
114"	590	610	769	931	1085	1251	1396	1562	1724	1882	2032	2199	2361	2531	2797	3061	3326	3590
120"	618	639	805	976	1143	1318	1472	1627	1814	1972	2134	2310	2472	2655	2932	3208	3484	3761
	single blind								2 blinds on one headrail								3 blinds on one headrail	
LightMaster™	45	53	61	69	85	98	113	126	138	151	162	171	183	196	240	264	289	317
Decorative Tapes (Solid)	28	36	45	49	61	69	73	85	94	102	110	118	126	134	162	175	200	215
Decorative Tapes (Pattern)	57	69	81	94	113	134	151	171	183	200	215	232	248	264	317	345	379	407

The maximum slat width is 96".

Shaded area requires multiple blinds per headrail. To price multiple blinds on a headrail, see price above based on overall width then add appropriate surcharge from below.

FREE OPTIONS
Must be requested at time of order.
Choice of Control Options: Tilter Left, Lift Cord Right (Standard) Tilter Right, Lift Cord Left All Left All Right
Choice of Style Package: Classique™ Value (Standard)
Choice of Tilting Control on Corded: Cord Wand
Extension Brackets (2" or 4")
Extended Valance (Up to 3" greater than ordered width)
Hold-down Brackets

SURCHARGE OPTIONS	
Cutouts: Side Cutout	Surcharges \$81 per side
Decorative Tapes: ½" Solid 1½" Solid 1½" Pattern	See Grid For Price See Grid For Price See Grid For Price
Extended Valance (3" and greater beyond order width)	\$66
LightMaster™	See Grid For Price
Multiple Blinds on One Headrail: 2 Blinds per Headrail 3 Blinds per Headrail	\$106 \$138
Replacement Slat	\$7
Replacement Valance	\$66

# Price Group G—2½" Resemblance™ Faux Wood Blinds

## AVAILABLE FINISHES

525DT001	Café	52567505	Rich Pine
52567504	Chocolate	52567501	Toasted Pecan

## AVAILABLE DECORATIVE TAPES

### 1½" And ½" Solid Fabrics

00301	Autumn	00138	Flax	00140	Powder
00352	Beach	00755	Merlot	00110	Pure
WH005	Blossom	00890	Midnight	GY002	Smoke
70802	Chapel	00504	Pesto	GY003	Steam
00378	Coffee	00162	Poupon		

## AVAILABLE DECORATIVE TAPES

### 1½" Pattern Fabrics

BR005	Coffee Leaves	01201	Glacier Ribbon	01237	Nautical Flax Stripe
BR003	Flora Cappuccino	BR002	Modern Filigree Flax	BR004	Threaded Flax
WH006	Flora Powder	NU008	Modern Filigree Stone		

## PRODUCT SPECIFICATIONS

### Ladder Spacing and Cord Count Charts

BLIND WIDTH				# OF TAPES OR LADDERS	# OF LIFT CORDS ON CORDED BLIND	# OF CORDS WITH CORDED PRIVACY
INSIDE MOUNT MINIMUM	INSIDE MOUNT MAXIMUM	OUTSIDE MOUNT MINIMUM	OUTSIDE MOUNT MAXIMUM			
7¾"	19½"	7¼"	19"	2	2	4
19⅝"	31½"	19⅛"	31"	3	2	4
31⅝"	43½"	31⅛"	43"	4	4	8
43⅝"	55½"	43⅛"	55"	5	3	6
55⅝"	67½"	55⅛"	67"	6	4	8
67⅝"	79½"	67⅛"	79"	7	4	8
79⅝"	96½"	79⅛"	96"	8	4	8

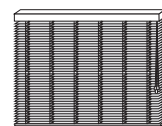

60" WIDE RESEMBLANCE

### Single Blind Minimum and Maximum Limitations

	MINIMUM WIDTH	MAXIMUM WIDTH	MINIMUM HEIGHT	MAXIMUM HEIGHT
Corded—Opposite Side Lift Controls without Tapes	11½"	96"	10"	120"
Corded—Opposite Side Lift Controls with Tapes	13¾"	96"	10"	120"
Center Tilt, No Lift Control without Tapes	9"	11⅜"	8"	120"
Center Tilt, No Lift Control with Tapes	9"	13⅜"	8"	120"
No Tilt or Lift Control with or without Tapes	7¼"	8⅞"	8"	120"
Cordless with or without Tapes	12½"	72"	10"	72"

See price grids for more details.



### Stacking Chart—Height Includes Headrail

BLIND HEIGHT	24"	36"	42"	48"	54"	60"	66"	72"	84"	96"	108"	120"
2½" Slats	3½"	4"	4½"	4¾"	5"	5¼"	5½"	6"	6½"	7"	7¾"	8¼"

Stacking dimensions are approximate.



# Price Group G—2½" Resemblance™ Faux Wood Blinds

Finishes available: Chocolate, Rich Pine, Toasted Pecan, Café

PRICE GROUP G																		
	Width to																	
	16"	23"	31"	36"	42"	48"	54"	60"	66"	72"	78"	84"	90"	96"	108"	120"	132"	144"
Height to 30"	140	171	235	290	326	390	431	494	541	577	634	666	713	782	901	988	1116	1206
36"	196	219	285	330	385	420	475	562	603	651	698	740	782	830	955	1048	1184	1280
42"	225	240	301	345	415	470	536	603	656	677	740	814	867	919	1060	1164	1315	1423
48"	235	255	326	385	440	520	570	682	729	823	873	893	978	1036	1191	1306	1475	1594
54"	270	290	360	420	500	561	630	755	823	901	988	1031	1094	1147	1318	1444	1628	1759
60"	290	308	366	449	530	605	700	802	875	973	1068	1147	1184	1306	1444	1581	1782	1924
Cordless 66"	310	322	369	488	570	650	771	921	968	1051	1178	1284	1388	1482	1636	1790	2016	2175
available up to 72"	335	356	424	517	625	710	835	942	1068	1178	1284	1395	1520	1576	1740	1904	2146	2317
78"	380	410	490	610	695	771	890	1025	1142	1301	1395	1520	1653	1800	1987	2174	2448	2642
84"	411	442	556	667	755	880	989	1115	1328	1455	1520	1614	1773	1959	2162	2366	2664	2875
90"	454	487	592	698	830	936	1078	1190	1350	1482	1597	1718	1889	2080	2294	2508	2824	3045
96"	480	518	614	734	873	983	1132	1301	1422	1586	1658	1805	1976	2174	2398	2624	2955	3188
102"	521	571	675	779	922	1048	1224	1350	1548	1663	1762	1910	2080	2251	2481	2711	3051	3291
108"	566	604	719	834	993	1125	1318	1410	1624	1751	1889	2014	2174	2311	2547	2783	3130	3376
114"	581	626	763	867	1038	1147	1356	1482	1723	1822	1938	2097	2284	2448	2706	2964		
120"	604	643	802	916	1082	1197	1416	1532	1828	1916	1993	2217	2388	2552	2822	3090		
	single blind					2 blinds on one headrail							3 blinds on one headrail				Not available	
Cordless	285					569							569					
LightMaster™	32	36	41	45	53	61	69	77	85	94	106	113	118	122	130	158	175	187
Decorative Tapes (Solid)	24	30	37	38	50	56	62	72	78	84	93	100	106	112	129	146	163	180
Decorative Tapes (Pattern)	52	63	72	82	97	112	127	145	155	173	184	202	214	224	252	295	324	357

The maximum slat width is 96".

Cordless upgrade maximum height is 72". If width is greater than 72", it requires two blinds on one headrail.

Shaded area requires multiple blinds per headrail. To price multiple blinds on a headrail, see price above based on overall width then add appropriate surcharge from below.

FREE OPTIONS	
Must be requested at time of order.	
Choice of Control Options:	Tilter Left, Lift Cord Right (Standard) Tilter Right, Lift Cord Left
Choice of Style Package:	Traditional (Standard) Contemporary (Optional)
Choice of Tilting Control on Corded:	Cord (not offered on Cordless) Wand
Extension Brackets (2" or 4")	
Extended Valance (Up to 3" greater than ordered width)	
Hold-down Brackets	

SURCHARGE OPTIONS	
Cordless:	Surcharges
1 Blind per Headrail	\$285
2 or 3 Blinds per Headrail	\$569
Cutouts (corded only):	
Side Cutout	\$57 per side
Decorative Tapes:	
½" Solid	See Grid For Price
1½" Solid	See Grid For Price
1½" Pattern	See Grid For Price
Extended Valance (3" and greater beyond order width)	\$45
LightMaster™	See Grid For Price
Multiple Blinds on One Headrail:	
2 Blinds per Headrail	\$98
3 Blinds per Headrail	\$126
Replacement Slat	\$7
Replacement Valance	\$45

## Price Group H—2" Variance Faux Wood Blinds

### AVAILABLE FINISHES

52067405 American Pine	52067200 Pale Ivory	520WH003 Silk
52067100 Brilliant White	52067160 Porcelain	52067410 Smoked Hickory
520DS007 Buckeye	520DS008 Rich Mahogany	520NU005 Swiss Chocolate
520MS009 Cherry Sangria	52067265 Sandblasted China	52067404 Warm Chestnut
52067130 China	52067371 Sandblasted Porcelain	
52067217 Colonial Oak	520NU006 Sandblasted Swiss Chocolate	

### AVAILABLE DECORATIVE TAPES

#### 1½" And ½" Solid Fabrics

00301 Autumn	00138 Flax	00140 Powder
00352 Beach	00755 Merlot	00110 Pure
WH005 Blossom	00890 Midnight	GY002 Smoke
70802 Chapel	00504 Pesto	GY003 Steam
00378 Coffee	00162 Poupon	

### AVAILABLE DECORATIVE TAPES

#### 1½" Pattern Fabrics

BR005 Coffee Leaves	01201 Glacier Ribbon	01237 Nautical Flax Stripe
BR003 Flora Cappuccino	BR002 Modern Filigree Flax	BR004 Threaded Flax
WH006 Flora Powder	NU008 Modern Filigree Stone	

## PRODUCT SPECIFICATIONS

### Ladder Spacing and Cord Count Charts

BLIND WIDTH				# OF TAPES OR LADDERS	# OF LIFT CORDS ON CORDED BLIND	# OF CORDS WITH CORDED PRIVACY
INSIDE MOUNT MINIMUM	INSIDE MOUNT MAXIMUM	OUTSIDE MOUNT MINIMUM	OUTSIDE MOUNT MAXIMUM			
7¾"	22"	7¼"	21½"	2	2	4
22⅛"	36½"	21⅝"	36"	3	2	4
36⅝"	51"	36⅛"	50½"	4	4	8
51⅛"	65½"	50⅝"	65"	5	3	6
65⅝"	80"	65⅛"	79½"	6	4	8
80⅛"	94½"	79⅝"	94"	7	4	8
94⅝"	96½"	94⅛"	96"	8	4	8

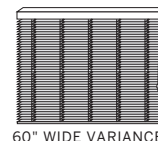

### Single Blind Minimum and Maximum Limitations

	MINIMUM WIDTH	MAXIMUM WIDTH	MINIMUM HEIGHT	MAXIMUM HEIGHT
Corded—Opposite Side Lift Controls without Tapes	11½"	96"	10"	120"
Corded—Opposite Side Lift Controls with Tapes	13¼"	96"	10"	120"
Center Tilt, No Lift Control without Tapes	9"	11⅜"	8"	120"
Center Tilt, No Lift Control with Tapes	9"	13⅜"	8"	120"
No Tilt or Lift Control with or without Tapes	7¼"	8⅞"	8"	120"
Cordless with or without Tapes	12½"	72"	10"	72"

See price grids for more details.



### Stacking Chart—Height Includes Headrail

BLIND HEIGHT	24"	36"	42"	48"	54"	60"	66"	72"	84"	96"	108"	120"
2" Slats	3¾"	4½"	5"	5½"	5¾"	6¼"	6½"	6¾"	7½"	8¼"	9"	10"

Stacking dimensions are approximate.

## Price Group H—2" Variance Faux Wood Blinds

**Finishes available:** Colonial Oak, Americana pine, Warm Chestnut, Smoked Hickory, Rich Mahogany, Buckeye, Cherry Sangria, Brilliant White, China, Porcelain, Sandblasted China, Pale Ivory, Sandblasted Porcelain, Swiss Chocolate, Sandblasted Swiss Chocolate, Silk

PRICE GROUP H																		
	Width to																	
	16"	23"	31"	36"	42"	48"	54"	60"	66"	72"	78"	84"	90"	96"	108"	120"	132"	144"
Height to 30"	196	228	285	326	362	386	443	517	541	573	671	707	744	792	952	1037	1114	1195
36"	215	244	309	370	435	484	553	602	651	716	773	817	870	931	1126	1232	1322	1427
42"	244	277	349	407	475	541	606	687	736	797	858	911	996	1061	1284	1390	1512	1627
48"	268	309	379	443	517	581	667	732	805	882	943	1016	1126	1191	1448	1569	1695	1821
54"	292	334	423	479	573	651	736	826	911	980	1077	1150	1232	1305	1586	1712	1850	1980
60"	326	374	451	517	630	728	822	927	1012	1106	1188	1277	1367	1452	1757	1910	2061	2216
Cordless 66"	354	407	484	562	707	797	911	1012	1110	1199	1301	1407	1501	1610	1940	2106	2281	2448
available up to 72"	386	439	549	602	764	866	980	1110	1212	1318	1419	1516	1642	1757	2127	2306	2493	2672
78"	423	475	586	703	846	943	1061	1191	1301	1423	1541	1646	1780	1899	2297	2493	2692	2891
84"	451	513	630	769	886	1012	1150	1284	1411	1520	1646	1785	1910	2045	2472	2687	2911	3126
90"	484	549	687	817	952	1086	1236	1371	1501	1642	1776	1915	2061	2195	2655	2891	3111	3343
96"	509	573	728	870	1012	1167	1301	1472	1610	1752	1903	2057	2204	2359	2846	3106	3347	3586
102"	537	609	769	931	1082	1240	1386	1561	1695	1866	2012	2183	2346	2500	3017	3281	3541	3801
108"	562	634	801	971	1126	1301	1452	1627	1793	1952	2114	2285	2455	2627	3171	3456	3720	3997
114"	589	671	841	1016	1191	1371	1541	1695	1887	2057	2220	2521	2578	2757	3343	3626		
120"	618	699	878	1065	1248	1435	1610	1776	1976	2155	2325	2638	2700	2895	3496	3797		
	single blind					2 blinds on one headrail						3 blinds on one headrail				Not available		
Cordless	285					569						569						
LightMaster™	36	49	61	69	85	98	110	126	134	147	158	171	183	196	236	256	289	330
Decorative Tapes (Solid)	24	32	41	45	57	66	73	81	89	98	106	113	122	130	158	171	191	121
Decorative Tapes (Pattern)	57	69	81	94	113	130	147	166	179	200	207	228	244	260	313	341	386	443

The maximum slat width is 96".

Cordless upgrade maximum height is 72". If width is greater than 72", it requires two blinds on one headrail.

Shaded area requires multiple blinds per headrail. To price multiple blinds on a headrail, see price above based on overall width then add appropriate surcharge from below.

FREE OPTIONS
Must be requested at time of order.
Choice of Control Options: Tilter Left, Lift Cord Right (Standard) Tilter Right, Lift Cord Left
Choice of Style Package: Traditional (Standard) Contemporary (Optional)
Choice of Tilting Control on Corded: Cord (not offered on Cordless) Wand
Extension Brackets (2" or 4")
Extended Valance (Up to 3" greater than ordered width)
Hold-down Brackets

SURCHARGE OPTIONS	
Cordless:	Surcharges
1 Blind per Headrail	\$285
2 or 3 Blinds per Headrail	\$569
Cutouts (corded only):	
Side Cutout	\$66 per side
Decorative Tapes:	
1/2" Solid	See Grid For Price
1 1/2" Solid	See Grid For Price
1 1/2" Pattern	See Grid For Price
Extended Valance (3" and greater beyond order width)	\$45
LightMaster™	See Grid For Price
Multiple Blinds on One Headrail:	
2 Blinds per Headrail	\$98
3 Blinds per Headrail	\$126
Replacement Slat	\$7
Replacement Valance	\$45

## Price Group J-2" Hardwood Blinds

### AVAILABLE FINISHES

52078082 American Pine	52002771 Colonial Oak	52002772 Persian Walnut
52002884 Basic Black	52081340 Dark Roast	52081019 Porcelain
52002321 Brilliant White	52002352 High Gloss Colonial Oak	520DS003 Rich Mahogany
520DS001 Buckeye	52081337 Light Cherry	520WH002 Silk
52081342 Burnt Cinnamon	52002798 Natural Grain	52078097 Smoked Hickory
52002908 China	52081341 Oldspice	520NU001 Swiss Chocolate
52081338 Cognac	52078027 Pale Ivory	52002777 Warm Chestnut

### AVAILABLE DECORATIVE TAPES

#### 1½" And ½" Solid Fabrics

00301 Autumn	00138 Flax	00140 Powder
00352 Beach	00755 Merlot	00110 Pure
WH005 Blossom	00890 Midnight	GY002 Smoke
70802 Chapel	00504 Pesto	GY003 Steam
00378 Coffee	00162 Poupon	

### AVAILABLE DECORATIVE TAPES

#### 1½" Pattern Fabrics

BR005 Coffee Leaves	01201 Glacier Ribbon	01237 Nautical Flax Stripe
BR003 Flora Cappuccino	BR002 Modern Filigree Flax	BR004 Threaded Flax
WH006 Flora Powder	NU008 Modern Filigree Stone	

## PRODUCT SPECIFICATIONS

### Ladder Spacing and Cord Count Charts

BLIND WIDTH				# OF TAPES OR LADDERS	# OF LIFT CORDS ON CORDED BLIND	# OF CORDS WITH CORDED PRIVACY	
INSIDE MOUNT MINIMUM	INSIDE MOUNT MAXIMUM	OUTSIDE MOUNT MINIMUM	OUTSIDE MOUNT MAXIMUM				
6½"	36½"	6"	36"	2	2	4	60" WIDE HARDWOOD
36⅝"	54½"	36⅞"	54"	3	2	4	
54⅝"	60½"	54⅞"	60"	3	3	6	
60⅝"	84½"	60⅞"	84"	4	4	8	
84⅝"	96½"	84⅞"	96"	5	3	6	

### Single Blind Minimum and Maximum Limitations

	MINIMUM WIDTH	MAXIMUM WIDTH	MINIMUM HEIGHT	MAXIMUM HEIGHT
Corded—Same Side Lift Controls with or without Tapes	20½"	96"	10"	120"
Corded—Opposite Side Lift Controls without Tapes	11½"	96"	10"	120"
Corded—Opposite Side Lift Controls with Tapes	13¼"	96"	10"	120"
Center Tilt, No Lift Control without Tapes	9"	11⅜"	8"	120"
Center Tilt, No Lift Control with Tapes	9"	13⅜"	8"	120"
No Tilt or Lift Control with or without Tapes	7¼"	8⅞"	8"	120"
Cordless with or without Tapes	12½"	90"	10"	84"

See price grids for more details.



### Stacking Chart—Height Includes Headrail

BLIND HEIGHT	24"	36"	42"	48"	54"	60"	66"	72"	84"	96"	108"	120"
2" Slats	3¾"	4½"	5"	5½"	5¾"	6¼"	6½"	6¾"	7½"	8¼"	9"	10"

Stacking dimensions are approximate.

## Price Group J-2" Hardwood Blinds

**Finishes available:** Colonial Oak, Americana Pine, Warm Chestnut, Smoked Hickory, Burnt Cinnamon, Cognac, Dark Roast, OldSpice, Persian Walnut, Natural Grain, High Gloss Colonial Oak, Basic Black, Light Cherry, Rich Mahogany, Buckeye, Brilliant White, China, Porcelain, Pale Ivory, Swiss Chocolate, Silk

PRICE GROUP J																		
	Width to																	
	16"	23"	31"	36"	42"	48"	54"	60"	66"	72"	78"	84"	90"	96"	108"	120"	132"	144"
Height to 30"	196	228	285	326	362	386	443	517	541	573	671	707	744	792	952	1037	1114	1195
36"	215	244	309	370	435	484	553	602	651	716	773	817	870	931	1126	1232	1322	1427
42"	244	277	349	407	475	541	606	687	736	797	858	911	996	1061	1284	1390	1512	1627
48"	268	309	379	443	517	581	667	732	805	882	943	1016	1126	1191	1448	1569	1695	1821
54"	292	334	423	479	573	651	736	826	911	980	1077	1150	1232	1305	1586	1712	1850	1980
60"	326	374	451	517	630	728	822	927	1012	1106	1188	1277	1367	1452	1757	1910	2061	2216
66"	354	407	484	562	707	797	911	1012	1110	1199	1301	1407	1501	1610	1940	2106	2281	2448
72"	386	439	549	602	764	866	980	1110	1212	1318	1419	1516	1642	1757	2127	2306	2493	2672
Cordless 78"	423	475	586	703	846	943	1061	1191	1301	1423	1541	1646	1780	1899	2297	2493	2692	2891
available up to 84"	451	513	630	769	886	1012	1150	1284	1411	1520	1646	1785	1910	2045	2472	2687	2911	3126
90"	484	549	687	817	952	1086	1236	1371	1501	1642	1776	1915	2061	2195	2655	2891	3111	3343
96"	509	573	728	870	1012	1167	1301	1472	1610	1752	1903	2057	2204	2359	2846	3106	3347	3586
102"	537	609	769	931	1082	1240	1386	1561	1695	1866	2012	2183	2346	2500	3017	3281	3541	3801
108"	562	634	801	971	1126	1301	1452	1627	1793	1952	2114	2285	2455	2627	3171	3456	3720	3997
114"	589	671	841	1016	1191	1371	1541	1695	1887	2057	2220	2521	2578	2757	3343	3626	3911	4196
120"	618	699	878	1065	1248	1435	1610	1776	1976	2155	2325	2638	2700	2895	3496	3797	4094	4395
	single blind								2 blinds on one headrail							3 blinds on one headrail		
Cordless	285								569							569		
LightMaster™	49	57	69	77	98	110	126	138	155	166	179	191	203	215	264	289	309	337
Decorative Tapes (Solid)	32	41	49	53	66	73	81	98	106	113	122	130	138	147	179	191	207	224
Decorative Tapes (Pattern)	69	77	94	106	126	147	166	187	203	224	240	256	277	292	354	382	415	443

The maximum slat width is 96".

Cordless upgrade maximum height is 84". If width is greater than 90", it requires two blinds on one headrail.

Shaded area requires multiple blinds per headrail. To price multiple blinds on a headrail, see price above based on overall width then add appropriate surcharge from below.

### FREE OPTIONS

Must be requested at time of order.

#### Choice of Control Options:

- Tilter Left, Lift Cord Right (Standard)
- Tilter Right, Lift Cord Left
- All Left
- All Right

#### Style Package:

- Traditional (Standard)
- Contemporary (Optional)

#### Choice of Tilting Control on Corded:

- Cord (not offered on Cordless)
- Wand

Extension Brackets (2" or 4")

Extended Valance (Under 3")

Hold-down Brackets

### SURCHARGE OPTIONS

#### Cordless:

Surcharges

1 Blind per Headrail

\$285

2 or 3 Blinds per Headrail

\$569

Cutouts

Side Cutout

\$81 per side

Decorative Tapes:

½" Solid

See Grid For Price

1½" Solid

See Grid For Price

1½" Pattern

See Grid For Price

Extended Valance

\$73

(3" and greater beyond order width)

LightMaster™

See Grid For Price

Multiple Blinds on One Headrail:

2 Blinds per Headrail

\$118

3 Blinds per Headrail

\$151

Replacement Slat

\$7

Replacement Valance

\$73

## Price Group K—1" Hardwood Blinds

### AVAILABLE FINISHES

51078082	American Pine	51002908	China	510DS003	Rich Mahogany
51002321	Brilliant White	51002771	Colonial Oak	51078097	Smoked Hickory
510DS001	Buckeye	51081019	Porcelain	51002777	Warm Chestnut

### AVAILABLE DECORATIVE TAPES

#### ½" Solid Fabrics

00301	Autumn	00138	Flax	00140	Powder
00352	Beach	00755	Merlot	00110	Pure
WH005	Blossom	00890	Midnight	GY002	Smoke
70802	Chapel	00504	Pesto	GY003	Steam
00378	Coffee	00162	Poupon		

## PRODUCT SPECIFICATIONS

### Ladder Spacing and Cord Count Charts

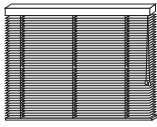
BLIND WIDTH				# OF TAPES OR LADDERS	# OF LIFT CORDS ON CORDED BLIND	# OF CORDS WITH CORDED PRIVACY	
INSIDE MOUNT MINIMUM	INSIDE MOUNT MAXIMUM	OUTSIDE MOUNT MINIMUM	OUTSIDE MOUNT MAXIMUM				
6½"	36½"	6"	36"	2	2	N/A	60" WIDE HARDWOOD
36⅝"	54½"	36⅝"	54"	3	2	N/A	
54⅝"	60½"	54⅝"	60"	3	3	N/A	
60⅝"	84½"	60⅝"	84"	4	4	N/A	
84⅝"	96½"	84⅝"	96"	5	3	N/A	

### Single Blind Minimum and Maximum Limitations

	MINIMUM WIDTH	MAXIMUM WIDTH	MINIMUM HEIGHT	MAXIMUM HEIGHT
Corded—Same Side Lift Controls with or without Tapes	18½"	96"	10"	120"
Corded—Opposite Side Lift Controls with or without Tapes	13"	96"	10"	120"
Center Tilt, No Lift Control without Tapes	8¾"	12⅞"	6"	120"
Center Tilt, No Lift Control with Tapes	9"	12⅞"	6"	120"
No Tilt or Lift Control without Tapes	6"	8⅝"	6"	120"
No Tilt or Lift Control with Tapes	7½"	8⅞"	6"	120"

See price grids for more details.



### Stacking Chart—Height Includes Headrail

BLIND HEIGHT	24"	36"	42"	48"	54"	60"	66"	72"	84"	96"	108"	120"
1" Slats	4¾"	6¼"	7¼"	8"	8¾"	9½"	10¼"	11"	12¾"	14½"	16"	17½"

Stacking dimensions are approximate.

## Price Group K—1" Hardwood Blinds

**Finishes available:** Colonial Oak, Americana Pine, Warm Chestnut, Smoked Hickory, Rich Mahogany, Buckeye, Brilliant White, China, Porcelain

PRICE GROUP K																			
Height to	Width to																		
	16"	23"	31"	36"	42"	48"	54"	60"	66"	72"	78"	84"	90"	96"	108"	120"	132"	144"	
30"	228	268	341	386	431	464	528	622	647	662	801	850	899	947	1146	1248	1350	1452	
36"	240	292	370	443	520	581	658	720	788	858	922	980	1049	1118	1350	1463	1578	1691	
42"	272	334	419	488	569	647	720	822	882	952	1029	1094	1195	1273	1533	1663	1793	1927	
48"	309	370	456	532	622	699	797	882	964	1057	1130	1224	1350	1439	1736	1887	2042	2191	
54"	334	402	504	577	687	777	882	992	1090	1179	1293	1371	1480	1578	1910	2074	2240	2411	
60"	370	451	545	626	760	875	988	1114	1216	1322	1423	1533	1639	1748	2110	2289	2468	2651	
66"	402	488	602	671	846	947	1090	1216	1342	1448	1557	1687	1805	1931	2334	2533	2732	2932	
72"	435	528	658	720	919	1049	1179	1342	1452	1578	1699	1829	1976	2110	2549	2768	2988	3216	
78"	475	569	703	846	988	1126	1280	1435	1561	1716	1854	1984	2138	2285	2764	3000	3245	3481	
84"	513	618	760	919	1065	1220	1371	1545	1687	1834	1988	2151	2293	2460	2968	3224	3477	3737	
90"	545	658	826	980	1143	1305	1476	1650	1810	1976	2131	2302	2472	2647	3192	3468	3745	4022	
96"	573	692	878	1049	1216	1395	1561	1761	1931	2102	2285	2468	2651	2834	3424	3720	4018	4314	
102"	609	736	927	1114	1297	1488	1667	1870	2045	2240	2432	2619	2813	3009	3590	3903	4220	4538	
108"	630	760	960	1163	1354	1561	1748	1959	2155	2346	2541	2745	2952	3160	3822	4152	4480	4818	
114"	643	801	1009	1220	1423	1646	1838	2042	2265	2468	2675	2883	3098	3322	4009	4350	4700	5046	
120"	699	846	1057	1280	1492	1728	1931	2123	2374	2590	2802	3025	3245	3477	4196	4554	4916	5281	
	single blind								2 blinds on one headrail						3 blinds on one headrail				
1/2" Decorative Tapes (Solid)	27	41	53	57	69	77	89	102	110	118	130	138	147	158	191	203	219	236	

The maximum slat width is 96".

Shaded area requires multiple blinds per headrail. To price multiple blinds on a headrail, see price above based on overall width then add appropriate surcharge from below.

### FREE OPTIONS

Must be requested at time of order.

#### Choice of Control Options:

- Tilter Left, Lift Cord Right (Standard)
- Tilter Right, Lift Cord Left
- All Left
- All Right

#### Choice of Style Package:

- Contemporary (Standard)

#### Tilting Control on Corded:

- Wand (Standard)

#### Extension Brackets (2" or 4")

#### Extended Valance (Up to 3" greater than ordered width)

#### Hold-down Brackets

### SURCHARGE OPTIONS

#### Cutouts:

- Side Cutout

#### Surcharges

- \$85 per side

#### Decorative Tapes:

- 1/2" Solid

- See Grid For Price

#### Extended Valance

- (3" and greater beyond order width)

- \$85

#### Multiple Blinds on One Headrail:

- 2 Blinds per Headrail

- 3 Blinds per Headrail

- \$122

- \$162

#### Replacement Slat

- \$7

#### Replacement Valance

- \$77

## Price Group L—2½" Hardwood Blinds

### AVAILABLE FINISHES

52578082	American Pine	52502908	China	525DS003	Rich Mahogany
52502321	Brilliant White	52502771	Colonial Oak	52578097	Smoked Hickory
525DS001	Buckeye	52581019	Porcelain	52502777	Warm Chestnut

### AVAILABLE DECORATIVE TAPES

#### 1½" And ½" Solid Fabrics

00301	Autumn	00138	Flax	00140	Powder
00352	Beach	00755	Merlot	00110	Pure
WH005	Blossom	00890	Midnight	GY002	Smoke
70802	Chapel	00504	Pesto	GY003	Steam
00378	Coffee	00162	Poupon		

### AVAILABLE DECORATIVE TAPES

#### 1½" Pattern Fabrics

BR005	Coffee Leaves	01201	Glacier Ribbon	01237	Nautical Flax Stripe
BR003	Flora Cappuccino	BR002	Modern Filigree Flax	BR004	Threaded Flax
WH006	Flora Powder	NU008	Modern Filigree Stone		

## PRODUCT SPECIFICATIONS

### Ladder Spacing and Cord Count Charts

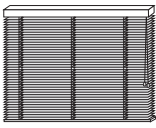
BLIND WIDTH				# OF TAPES OR LADDERS	# OF LIFT CORDS ON CORDED BLIND	# OF CORDS WITH CORDED PRIVACY	
INSIDE MOUNT MINIMUM	INSIDE MOUNT MAXIMUM	OUTSIDE MOUNT MINIMUM	OUTSIDE MOUNT MAXIMUM				
6½"	36½"	6"	36"	2	2	4	60" WIDE HARDWOOD
36⅝"	54½"	36⅞"	54"	3	2	4	
54⅝"	60½"	54⅞"	60"	3	3	6	
60⅝"	84½"	60⅞"	84"	4	4	8	
84⅝"	96½"	84⅞"	96"	5	3	6	

### Single Blind Minimum and Maximum Limitations

	MINIMUM WIDTH	MAXIMUM WIDTH	MINIMUM HEIGHT	MAXIMUM HEIGHT
Corded—Same Side Lift Controls with or without Tapes	20½"	84"	10"	120"
Corded—Opposite Side Lift Controls with or without Tapes	11½"	84"	10"	120"
Center Tilt, No Lift Control without Tapes	9"	11⅜"	8"	120"
Center Tilt, No Lift Control with Tapes	9"	13⅜"	8"	120"
No Tilt or Lift Control with or without Tapes	7¼"	8⅞"	8"	120"
Cordless with or without Tapes	12½"	84"	10"	84"

See price grids for more details.



### Stacking Chart—Height Includes Headrail

BLIND HEIGHT	24"	36"	42"	48"	54"	60"	66"	72"	84"	96"	108"	120"
2½" Slats	3½"	4"	4½"	4¾"	5"	5¼"	5½"	6"	6½"	7"	7¾"	8¼"

Stacking dimensions are approximate.



## Price Group L—2½" Hardwood Blinds

**Finishes available:** Colonial Oak, Americana Pine, Warm Chestnut, Smoked Hickory, Rich Mahogany, Buckeye, Brilliant White, China, Porcelain

PRICE GROUP L																			
	Width to																		
	16"	23"	31"	36"	42"	48"	54"	60"	66"	72"	78"	84"	90"	96"	108"	120"	132"	144"	
Height to 30"	224	268	337	386	431	468	528	622	651	662	801	850	894	947	1150	1248	1350	1452	
36"	240	292	370	443	520	581	658	724	788	858	922	980	1049	1118	1350	1463	1578	1691	
42"	272	334	419	488	569	651	724	822	882	952	1029	1090	1195	1269	1533	1663	1793	1927	
48"	309	370	456	528	622	699	797	882	967	1057	1130	1220	1350	1439	1736	1887	2042	2191	
54"	334	407	504	577	687	781	882	992	1090	1179	1293	1371	1480	1578	1910	2074	2240	2411	
60"	370	451	545	626	760	875	988	1114	1212	1322	1423	1533	1639	1748	2110	2289	2468	2651	
66"	402	488	602	671	846	947	1090	1212	1342	1448	1557	1687	1805	1931	2330	2533	2732	2932	
72"	435	528	658	724	919	1049	1179	1342	1452	1578	1699	1825	1976	2110	2549	2764	2988	3216	
Cordless 78"	475	569	703	846	988	1126	1280	1435	1561	1716	1854	1984	2138	2285	2761	3000	3245	3481	
available up to 84"	513	618	760	919	1065	1220	1371	1545	1687	1829	1988	2147	2293	2460	2968	3224	3477	3737	
90"	545	658	826	980	1143	1305	1476	1646	1810	1976	2131	2302	2472	2643	3192	3468	3745	4018	
96"	573	692	878	1049	1212	1395	1561	1761	1931	2102	2285	2468	2651	2834	3424	3720	4018	4314	
102"	609	736	927	1114	1297	1488	1667	1870	2045	2240	2432	2619	2813	3009	3590	3903	4220	4538	
108"	630	760	960	1163	1354	1561	1748	1955	2155	2346	2541	2745	2947	3160	3818	4152	4480	4814	
114"	642	801	1009	1220	1423	1646	1842	2042	2269	2468	2675	2883	3098	3318	4005	4350	4700	5046	
120"	699	846	1057	1280	1492	1728	1931	2123	2374	2590	2802	3021	3245	3477	4192	4554	4916	5281	
	single blind								2 blinds on one headrail						3 blinds on one headrail				
Cordless	285								569						569				
LightMaster™	49	57	69	77	94	106	126	138	151	162	175	187	200	211	260	281	305	330	
Decorative Tapes (Solid)	41	49	57	61	73	81	89	113	122	130	138	147	155	162	200	211	224	228	
Decorative Tapes (Pattern)	81	85	106	110	138	162	187	207	228	248	272	285	309	326	394	423	443	443	

The maximum slat width is 96".

Cordless upgrade maximum height is 84". If width is greater than 84", it requires two blinds on one headrail.

Shaded area requires multiple blinds per headrail. To price multiple blinds on a headrail, see price above based on overall width then add appropriate surcharge from below.

### FREE OPTIONS

Must be requested at time of order.

#### Choice of Control Options:

- Tilter Left, Lift Cord Right (Standard)
- Tilter Right, Lift Cord Left
- All Left
- All Right

#### Choice of Style Package:

- Traditional (Standard)
- Contemporary (Optional)

#### Choice of Tilting Control on Corded:

- Cord (not offered on Cordless)
- Wand

#### Extension Brackets (2" or 4")

- Extended Valance (Up to 3" greater than ordered width)
- Hold-down Brackets

### SURCHARGE OPTIONS

#### Cordless:

- |                            |       |
|----------------------------|-------|
| 1 Blind per Headrail       | \$285 |
| 2 or 3 Blinds per Headrail | \$569 |

#### Cutouts (corded only):

- |             |               |
|-------------|---------------|
| Side Cutout | \$77 per side |
|-------------|---------------|

#### Decorative Tapes:

- |             |                    |
|-------------|--------------------|
| ½" Solid    | See Grid For Price |
| 1½" Solid   | See Grid For Price |
| 1½" Pattern | See Grid For Price |

#### Extended Valance

- |                                     |      |
|-------------------------------------|------|
| (3" and greater beyond order width) | \$85 |
|-------------------------------------|------|

#### LightMaster™

- |  |                    |
|--|--------------------|
|  | See Grid For Price |
|--|--------------------|

#### Multiple Blinds on One Headrail:

- |                       |       |
|-----------------------|-------|
| 2 Blinds per Headrail | \$147 |
| 3 Blinds per Headrail | \$187 |

#### Replacement Slat

- |  |     |
|--|-----|
|  | \$7 |
|--|-----|

#### Replacement Valance

- |  |      |
|--|------|
|  | \$85 |
|--|------|

## Price Group M—2" Hardwood Blinds

### AVAILABLE FINISHES

520MS001 Cherry Sangria	52081089 Sandblasted Porcelain
520LS006 Pure Maple	520NU002 Sandblasted Swiss Chocolate
52002909 Sandblasted China	

### AVAILABLE DECORATIVE TAPES

#### 1½" And ½" Solid Fabrics

00301 Autumn	00138 Flax	00140 Powder
00352 Beach	00755 Merlot	00110 Pure
WH005 Blossom	00890 Midnight	GY002 Smoke
70802 Chapel	00504 Pesto	GY003 Steam
00378 Coffee	00162 Poupon	

### AVAILABLE DECORATIVE TAPES

#### 1½" Pattern Fabrics

BR005 Coffee Leaves	01201 Glacier Ribbon	01237 Nautical Flax Stripe
BR003 Flora Cappuccino	BR002 Modern Filigree Flax	BR004 Threaded Flax
WH006 Flora Powder	NU008 Modern Filigree Stone	

## PRODUCT SPECIFICATIONS

### Ladder Spacing and Cord Count Charts

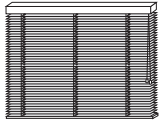
BLIND WIDTH				# OF TAPES OR LADDERS	# OF LIFT CORDS ON CORDED BLIND	# OF CORDS WITH CORDED PRIVACY	
INSIDE MOUNT MINIMUM	INSIDE MOUNT MAXIMUM	OUTSIDE MOUNT MINIMUM	OUTSIDE MOUNT MAXIMUM				
6½"	36½"	6"	36"	2	2	4	60" WIDE HARDWOOD
36⅝"	54½"	36⅛"	54"	3	2	4	
54⅝"	60½"	54⅛"	60"	3	3	6	
60⅝"	84½"	60⅛"	84"	4	4	8	
84⅝"	96½"	84⅛"	96"	5	3	6	

### Single Blind Minimum and Maximum Limitations

	MINIMUM WIDTH	MAXIMUM WIDTH	MINIMUM HEIGHT	MAXIMUM HEIGHT
Corded—Same Side Lift Controls with or without Tapes	20½"	96"	10"	120"
Corded—Opposite Side Lift Controls without Tapes	11½"	96"	10"	120"
Corded—Opposite Side Lift Controls with Tapes	13¼"	96"	10"	120"
Center Tilt, No Lift Control without Tapes	9"	11⅜"	8"	120"
Center Tilt, No Lift Control with Tapes	9"	13⅜"	8"	120"
No Tilt or Lift Control with or without Tapes	7¼"	8⅞"	8"	120"
Cordless with or without Tapes	12½"	90"	10"	84"

See price grids for more details.



### Stacking Chart—Height Includes Headrail

BLIND HEIGHT	24"	36"	42"	48"	54"	60"	66"	72"	84"	96"	108"	120"
2" Slats	3¾"	4½"	5"	5½"	5¾"	6¼"	6½"	6¾"	7½"	8¼"	9"	10"

Stacking dimensions are approximate.

# Price Group M—2" Hardwood Blinds

Finishes available: Cherry Sangria, Pure Maple, Sandblasted China, Sandblasted Porcelain, Sandblasted Swiss Chocolate

PRICE GROUP M																		
	Width to																	
	16"	23"	31"	36"	42"	48"	54"	60"	66"	72"	78"	84"	90"	96"	108"	120"	132"	144"
Height to 30"	224	268	337	390	431	468	528	622	643	662	801	846	894	943	1146	1244	1350	1448
36"	240	292	370	439	520	577	658	724	788	858	922	976	1049	1118	1350	1463	1582	1691
42"	272	337	415	488	569	651	724	822	882	952	1029	1094	1195	1269	1533	1663	1793	1923
48"	309	370	456	532	622	699	797	878	967	1057	1130	1224	1350	1435	1736	1887	2042	2187
54"	334	407	504	573	687	781	882	992	1086	1175	1293	1374	1476	1582	1910	2070	2240	2403
60"	370	451	545	626	760	875	988	1110	1216	1322	1423	1533	1635	1748	2110	2289	2468	2651
66"	402	488	602	671	841	947	1086	1207	1337	1448	1557	1687	1805	1931	2330	2533	2732	2932
72"	435	528	658	724	919	1049	1179	1337	1452	1574	1704	1825	1972	2110	2549	2764	2988	3213
Cordless 78"	475	569	703	846	988	1126	1280	1435	1561	1716	1850	1984	2138	2285	2764	3000	3245	3481
available up to 84"	513	614	760	919	1065	1220	1371	1541	1687	1834	1984	2151	2293	2460	2968	3224	3477	3733
90"	545	658	826	976	1139	1305	1476	1650	1810	1972	2131	2302	2476	2647	3192	3468	3741	4022
96"	573	692	875	1049	1207	1399	1561	1761	1931	2102	2285	2468	2651	2834	3424	3720	4018	4306
102"	609	736	927	1110	1297	1488	1680	1870	2045	2240	2444	2619	2809	3009	3643	3956	4269	4586
108"	630	760	964	1163	1354	1561	1744	1955	2155	2350	2541	2745	2947	3160	3818	4152	4480	4810
114"	661	801	1009	1220	1423	1642	1842	2042	2261	2472	2668	2887	3098	3313	4009	4350	4700	5046
120"	699	841	1057	1277	1492	1728	1931	2123	2374	2590	2798	3025	3245	3477	4192	4554	4916	5278
	single blind								2 blinds on one headrail							3 blinds on one headrail		
Cordless	285								569							569		
LightMaster™	49	57	69	77	98	110	126	138	155	166	179	191	203	215	264	289	309	337
Decorative Tapes (Solid)	32	41	49	53	66	73	81	98	106	113	122	130	138	147	179	191	207	224
Decorative Tapes (Pattern)	69	77	94	106	126	147	166	137	203	224	240	256	277	292	354	382	415	443

The maximum slat width is 96".

Cordless upgrade maximum height is 84". If width is greater than 90", it requires two blinds on one headrail.

Shaded area requires multiple blinds per headrail. To price multiple blinds on a headrail, see price above based on overall width then add appropriate surcharge from below.

FREE OPTIONS
Must be requested at time of order.
Choice of Control Options: Tilter Left, Lift Cord Right (Standard) Tilter Right, Lift Cord Left All Left All Right
Choice of Style Package: Traditional (Standard) Contemporary (Optional)
Choice of Tilting Control on Corded: Cord (not offered on Cordless) Wand
Extension Brackets (2" or 4")
Extended Valance (Up to 3" greater than ordered width)
Hold-down Brackets

SURCHARGE OPTIONS	
Cordless:	Surcharges
1 Blind per Headrail	\$285
2 or 3 Blinds per Headrail	\$569
Cutouts	
Side Cutout	\$81 per side
Decorative Tapes:	
1/2" Solid	See Grid For Price
1 1/2" Solid	See Grid For Price
1 1/2" Pattern	See Grid For Price
Extended Valance	\$73
(3" and greater beyond order width)	
LightMaster™	See Grid For Price
Multiple Blinds on One Headrail:	
2 Blinds per Headrail	\$118
3 Blinds per Headrail	\$151
Replacement Slat	\$7
Replacement Valance	\$73

## Price Group N—2" Hardwood Blinds

### AVAILABLE FINISHES

520DS005 Black Walnut	520DS002 Gray Embers	52002888 Heirloom Oak
520MS004 English Gray	52002897 Heirloom Autumn	520LS008 Natural Pine
520LS005 European Maple	520WH001 Heirloom Ivory	520LS003 White Ash

### AVAILABLE DECORATIVE TAPES

#### 1½" And ½" Solid Fabrics

00301 Autumn	00138 Flax	00140 Powder
00352 Beach	00755 Merlot	00110 Pure
WH005 Blossom	00890 Midnight	GY002 Smoke
70802 Chapel	00504 Pesto	GY003 Steam
00378 Coffee	00162 Poupon	

### AVAILABLE DECORATIVE TAPES

#### 1½" Pattern Fabrics

BR005 Coffee Leaves	01201 Glacier Ribbon	01237 Nautical Flax Stripe
BR003 Flora Cappuccino	BR002 Modern Filigree Flax	BR004 Threaded Flax
WH006 Flora Powder	NU008 Modern Filigree Stone	

## PRODUCT SPECIFICATIONS

### Ladder Spacing and Cord Count Charts

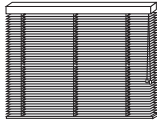
BLIND WIDTH				# OF TAPES OR LADDERS	# OF LIFT CORDS ON CORDED BLIND	# OF CORDS WITH CORDED PRIVACY	
INSIDE MOUNT MINIMUM	INSIDE MOUNT MAXIMUM	OUTSIDE MOUNT MINIMUM	OUTSIDE MOUNT MAXIMUM				
6½"	36½"	6"	36"	2	2	4	60" WIDE HARDWOOD
36⅝"	54½"	36⅞"	54"	3	2	4	
54⅞"	60½"	54⅞"	60"	3	3	6	
60⅞"	84½"	60⅞"	84"	4	4	8	
84⅞"	96½"	84⅞"	96"	5	3	6	

### Single Blind Minimum and Maximum Limitations

	MINIMUM WIDTH	MAXIMUM WIDTH	MINIMUM HEIGHT	MAXIMUM HEIGHT
Corded—Same Side Lift Controls with or without Tapes	20½"	96"	10"	120"
Corded—Opposite Side Lift Controls without Tapes	11½"	96"	10"	120"
Corded—Opposite Side Lift Controls with Tapes	13¼"	96"	10"	120"
Center Tilt, No Lift Control without Tapes	9"	11⅜"	8"	120"
Center Tilt, No Lift Control with Tapes	9"	13⅜"	8"	120"
No Tilt or Lift Control with or without Tapes	7¼"	8⅞"	8"	120"
Cordless with or without Tapes	12½"	90"	10"	84"

See price grids for more details.



### Stacking Chart—Height Includes Headrail

BLIND HEIGHT	24"	36"	42"	48"	54"	60"	66"	72"	84"	96"	108"	120"
2" Slats	3¾"	4½"	5"	5½"	5¾"	6¼"	6½"	6¾"	7½"	8¼"	9"	10"

Stacking dimensions are approximate.

## Price Group N—2" Hardwood Blinds

**Finishes available:** Gray Embers, Natural Pine, English Grey, Heirloom Ivory, Black Walnut, European Maple, White Ash, Heirloom Autumn Heirloom Oak

PRICE GROUP N																		
	Width to																	
	16"	23"	31"	36"	42"	48"	54"	60"	66"	72"	78"	84"	90"	96"	108"	120"	132"	144"
Height to 30"	305	401	518	601	658	716	808	948	984	1010	1244	1315	1382	1480	1843	1990	2198	2351
36"	350	440	562	676	795	891	1006	1107	1199	1312	1435	1520	1628	1740	2155	2334	2585	2750
42"	409	514	636	747	878	984	1107	1247	1348	1458	1606	1699	1861	1985	2453	2674	2932	3138
48"	457	571	694	812	948	1071	1217	1348	1476	1612	1767	1909	2098	2228	2780	3014	3301	3548
54"	492	619	769	883	1049	1194	1348	1519	1664	1800	2004	2142	2294	2460	3042	3318	3647	3904
60"	549	666	811	931	1164	1335	1502	1691	1849	2016	2228	2384	2563	2724	3368	3662	4022	4320
66"	593	726	850	999	1282	1449	1664	1849	2033	2205	2428	2630	2817	3010	3730	4052	4442	4774
72"	646	785	978	1075	1397	1598	1800	2033	2221	2451	2656	2849	3068	3274	4071	4420	4848	5204
Cordless 78"	698	878	1075	1286	1502	1717	1950	2187	2438	2656	2871	3086	3319	3658	4420	4787	5274	5653
available up to 84"	759	940	1164	1392	1629	1857	2099	2393	2621	2849	3086	3340	3662	3924	4737	5137	5648	6055
90"	823	1024	1283	1520	1780	2030	2294	2563	2809	3072	3319	3685	3947	4222	5091	5528	6069	6504
96"	859	1073	1359	1628	1882	2174	2438	2741	3006	3270	3652	3956	4227	4517	5481	5936	6527	7004
102"	937	1172	1475	1769	2063	2375	2660	2995	3262	3574	3859	4177	4521	4819	5803	6309	6930	7430
108"	974	1218	1535	1856	2155	2504	2793	3134	3441	3753	4057	4374	4714	5040	6092	6611	7252	7804
114"	1022	1282	1613	1953	2265	2632	2940	3262	3616	3942	4268	4622	4967	5306	6414	6956	7636	8206
120"	1075	1342	1686	2039	2380	2752	3088	3390	3786	4139	4470	4842	5210	5555	6712	7291	8001	8604
	single blind								2 blinds on one headrail								3 blinds on one headrail	
Cordless	285								569								569	
LightMaster™	49	57	69	77	98	110	126	138	155	166	179	191	203	215	264	289	309	337
Decorative Tapes (Solid)	32	41	49	53	66	73	81	98	106	113	122	130	138	147	179	191	207	224
Decorative Tapes (Pattern)	69	77	94	106	126	147	166	187	203	224	240	256	277	292	354	382	415	443

The maximum slat width is 96".

Cordless upgrade maximum height is 84". If width is greater than 90", it requires two blinds on one headrail.

Shaded area requires multiple blinds per headrail. To price multiple blinds on a headrail, see price above based on overall width then add appropriate surcharge from below.

FREE OPTIONS
Must be requested at time of order.
Choice of Control Options: Tilter Left, Lift Cord Right (Standard) Tilter Right, Lift Cord Left All Left All Right
Choice of Style Package: Traditional (Standard) Contemporary (Optional)
Choice of Tilting Control on Corded: Cord (not offered on Cordless) Wand
Extension Brackets (2" or 4")
Extended Valance (Up to 3" greater than ordered width)
Hold-down Brackets

SURCHARGE OPTIONS	
Cordless:	Surcharges
1 Blind per Headrail	\$285
2 or 3 Blinds per Headrail	\$569
Cutouts	
Side Cutout	\$81 per side
Decorative Tapes:	
½" Solid	See Grid For Price
1½" Solid	See Grid For Price
1½" Pattern	See Grid For Price
Extended Valance (3" and greater beyond order width)	\$73
LightMaster™	See Grid For Price
Multiple Blinds on One Headrail:	
2 Blinds per Headrail	\$118
3 Blinds per Headrail	\$151
Replacement Slat	\$7
Replacement Valance	\$73

## Price Group O-1" Hardwood Blinds

### AVAILABLE FINISHES

510MS001 Cherry Sangria	51002888 Heirloom Oak
-------------------------	-----------------------

### AVAILABLE DECORATIVE TAPES

#### ½" Solid Fabrics

00301 Autumn	00138 Flax	00140 Powder
00352 Beach	00755 Merlot	00110 Pure
WH005 Blossom	00890 Midnight	GY002 Smoke
70802 Chapel	00504 Pesto	GY003 Steam
00378 Coffee	00162 Poupon	

## PRODUCT SPECIFICATIONS

### Ladder Spacing and Cord Count Charts

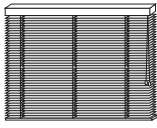
BLIND WIDTH				# OF TAPES OR LADDERS	# OF LIFT CORDS ON CORDED BLIND	# OF CORDS WITH CORDED PRIVACY	
INSIDE MOUNT MINIMUM	INSIDE MOUNT MAXIMUM	OUTSIDE MOUNT MINIMUM	OUTSIDE MOUNT MAXIMUM				
6½"	36½"	6"	36"	2	2	N/A	60" WIDE HARDWOOD
36⅝"	54½"	36⅞"	54"	3	2	N/A	
54⅝"	60½"	54⅞"	60"	3	3	N/A	
60⅝"	84½"	60⅞"	84"	4	4	N/A	
84⅝"	96½"	84⅞"	96"	5	3	N/A	

### Single Blind Minimum and Maximum Limitations

	MINIMUM WIDTH	MAXIMUM WIDTH	MINIMUM HEIGHT	MAXIMUM HEIGHT
Corded—Same Side Lift Controls with or without Tapes	18½"	96"	10"	120"
Corded—Opposite Side Lift Controls with or without Tapes	13"	96"	10"	120"
Center Tilt, No Lift Control without Tapes	8¾"	12⅞"	6"	120"
Center Tilt, No Lift Control with Tapes	9"	12⅞"	6"	120"
No Tilt or Lift Control without Tapes	6"	8⅝"	6"	120"
No Tilt or Lift Control with Tapes	7½"	8⅞"	6"	120"

See price grids for more details.



### Stacking Chart—Height Includes Headrail

BLIND HEIGHT	24"	36"	42"	48"	54"	60"	66"	72"	84"	96"	108"	120"
1" Slats	4¾"	6¼"	7¼"	8"	8¾"	9½"	10¼"	11"	12¾"	14½"	16"	17½"

Stacking dimensions are approximate.

# Price Group O—1" Hardwood Blinds

Finishes available: Cherry Sangria, Heirloom Oak

PRICE GROUP O																			
Height to	Width to	16"	23"	31"	36"	42"	48"	54"	60"	66"	72"	78"	84"	90"	96"	108"	120"	132"	144"
	30"	402	475	528	639	736	833	927	1005	1106	1220	1297	1390	1492	1610	1842	2110	2411	2757
36"	492	528	614	711	801	911	1005	1118	1220	1314	1423	1512	1602	1716	1955	2236	2562	2928	
42"	537	581	699	805	894	1012	1130	1248	1371	1476	1594	1699	1801	1923	2200	2513	2879	3294	
48"	606	651	769	882	984	1118	1236	1378	1512	1659	1793	1931	2074	2208	2529	2898	3313	3790	
54"	651	703	826	956	1073	1220	1371	1525	1680	1825	1980	2131	2289	2440	2793	3192	3660	4180	
60"	703	760	894	1041	1171	1333	1501	1667	1838	2008	2172	2330	2500	2668	3049	3492	4001	4578	
66"	760	826	980	1150	1280	1463	1655	1838	2037	2208	2378	2574	2764	2960	3387	3871	4427	5066	
72"	830	894	1069	1244	1403	1602	1797	2008	2220	2407	2610	2822	3013	3220	3684	4216	4830	5526	
78"	854	922	1101	1314	1525	1740	1964	2183	2407	2610	2822	3045	3257	3484	3988	4561	5225	5977	
84"	922	996	1195	1419	1639	1874	2118	2355	2582	2806	3045	3277	3509	3752	4297	4920	5627	6437	
90"	971	1049	1269	1508	1761	2017	2269	2521	2777	3021	3257	3484	3728	3988	4561	5225	5977	6843	
96"	1012	1090	1342	1614	1874	2147	2419	2687	2964	3220	3439	3684	3940	4216	4830	5526	6322	7233	
102"	1090	1175	1419	1708	1997	2285	2574	2851	3135	3354	3590	3842	4107	4399	5029	5762	6590	7542	
108"	1146	1236	1508	1814	2118	2407	2724	3021	3318	3554	3801	4062	4350	4651	5319	6094	6973	7981	
114"	1204	1297	1586	1910	2236	2549	2870	3188	3411	3647	3903	4176	4469	4778	5468	6262	7160	8197	
120"	1265	1358	1675	2025	2346	2675	3013	3358	3594	3846	4111	4403	4708	5042	5766	6599	7555	8640	
	single blind									2 blinds on one headrail							3 blinds on one headrail		
1/2" Decorative Tapes (Solid)	27	41	53	57	69	77	89	102	110	118	130	138	147	158	191	203	219	236	

The maximum slat width is 96".

Shaded area requires multiple blinds per headrail. To price multiple blinds on a headrail, see price above based on overall width then add appropriate surcharge from below.

### FREE OPTIONS

Must be requested at time of order.

Choice of Control Options:

- Tilter Left, Lift Cord Right (Standard)
- Tilter Right, Lift Cord Left
- All Left
- All Right

Choice of Style Package:

- Contemporary (Standard)

Choice of Tilting Control on Corded:

- Wand (Standard)

Extension Brackets (2" or 4")

Extended Valance (Up to 3" greater than ordered width)

Hold-down Brackets

### SURCHARGE OPTIONS

Surcharges

Cutouts:

- Side Cutout \$85 per side

Decorative Tapes:

- 1/2" Solid See Grid For Price

Extended Valance

- (3" and greater beyond order width) \$85

Multiple Blinds on One Headrail:

- 2 Blinds per Headrail \$122
- 3 Blinds per Headrail \$162

Replacement Slat

- \$7

Replacement Valance

- \$77

## Price Group P-2½" Hardwood Blinds

### AVAILABLE FINISHES

525MS001 Cherry Sangria	52502888 Heirloom Oak
-------------------------	-----------------------

### AVAILABLE DECORATIVE TAPES

#### 1½" And ½" Solid Fabrics

00301 Autumn	00138 Flax	00140 Powder
00352 Beach	00755 Merlot	00110 Pure
WH005 Blossom	00890 Midnight	GY002 Smoke
70802 Chapel	00504 Pesto	GY003 Steam
00378 Coffee	00162 Poupon	

### AVAILABLE DECORATIVE TAPES

#### 1½" Pattern Fabrics

BR005 Coffee Leaves	01201 Glacier Ribbon	01237 Nautical Flax Stripe
BR003 Flora Cappuccino	BR002 Modern Filigree Flax	BR004 Threaded Flax
WH006 Flora Powder	NU008 Modern Filigree Stone	

## PRODUCT SPECIFICATIONS

### Ladder Spacing and Cord Count Charts

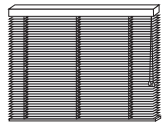
BLIND WIDTH				# OF TAPES OR LADDERS	# OF LIFT CORDS ON CORDED BLIND	# OF CORDS WITH CORDED PRIVACY	
INSIDE MOUNT MINIMUM	INSIDE MOUNT MAXIMUM	OUTSIDE MOUNT MINIMUM	OUTSIDE MOUNT MAXIMUM				
6½"	36½"	6"	36"	2	2	4	60" WIDE HARDWOOD
36⅝"	54½"	36⅞"	54"	3	2	4	
54⅝"	60½"	54⅞"	60"	3	3	6	
60⅝"	84½"	60⅞"	84"	4	4	8	
84⅝"	96½"	84⅞"	96"	5	3	6	

### Single Blind Minimum and Maximum Limitations

	MINIMUM WIDTH	MAXIMUM WIDTH	MINIMUM HEIGHT	MAXIMUM HEIGHT
Corded—Same Side Lift Controls with or without Tapes	20½"	84"	10"	120"
Corded—Opposite Side Lift Controls with or without Tapes	11½"	84"	10"	120"
Center Tilt, No Lift Control without Tapes	9"	11⅜"	8"	120"
Center Tilt, No Lift Control with Tapes	9"	13⅜"	8"	120"
No Tilt or Lift Control with or without Tapes	7¼"	8⅞"	8"	120"
Cordless with or without Tapes	12½"	84"	10"	84"

See price grids for more details.



### Stacking Chart—Height Includes Headrail

BLIND HEIGHT	24"	36"	42"	48"	54"	60"	66"	72"	84"	96"	108"	120"
2½" Slats	3½"	4"	4½"	4¾"	5"	5¼"	5½"	6"	6½"	7"	7¾"	8¼"

Stacking dimensions are approximate.



# Price Group P-2½" Hardwood Blinds

Finishes available: Cherry Sangria, Heirloom Oak

PRICE GROUP P																			
	Width to																		
	16"	23"	31"	36"	42"	48"	54"	60"	66"	72"	78"	84"	90"	96"	108"	120"	132"	144"	
Height to 30"	402	475	528	639	736	833	927	1005	1106	1220	1297	1390	1492	1610	1842	2110	2411	2757	
36"	492	528	614	711	801	911	1005	1118	1220	1314	1423	1512	1602	1716	1955	2236	2562	2928	
42"	537	581	699	805	894	1012	1130	1248	1371	1476	1594	1699	1801	1923	2200	2513	2879	3294	
48"	606	651	769	882	984	1118	1236	1378	1512	1659	1793	1931	2074	2208	2529	2898	3313	3790	
54"	651	703	826	956	1073	1220	1371	1525	1680	1825	1980	2131	2289	2440	2793	3192	3660	4180	
60"	703	760	894	1041	1171	1333	1501	1667	1838	2008	2172	2330	2500	2668	3049	3492	4001	4578	
66"	760	826	980	1150	1280	1463	1655	1838	2037	2208	2378	2574	2764	2960	3387	3871	4427	5066	
72"	830	894	1069	1244	1403	1602	1797	2008	2220	2407	2610	2822	3013	3220	3684	4216	4830	5526	
78"	854	922	1101	1314	1525	1740	1964	2183	2407	2610	2822	3045	3257	3484	3988	4561	5225	5977	
Cordless available up to 84"	922	996	1195	1419	1639	1874	2118	2355	2582	2806	3045	3277	3509	3752	4297	4920	5627	6437	
90"	971	1049	1269	1508	1761	2017	2269	2521	2777	3021	3257	3484	3728	3988	4561	5225	5977	6843	
96"	1012	1090	1342	1614	1874	2147	2419	2687	2964	3220	3439	3684	3940	4216	4830	5526	6322	7233	
102"	1090	1175	1419	1708	1997	2285	2574	2851	3135	3354	3590	3842	4107	4399	5029	5762	6590	7542	
108"	1146	1236	1508	1814	2118	2407	2724	3021	3318	3554	3801	4062	4350	4651	5319	6094	6973	7981	
114"	1204	1297	1586	1910	2236	2549	2870	3188	3411	3647	3903	4176	4469	4778	5468	6262	7160	8197	
120"	1265	1358	1675	2025	2346	2675	3013	3358	3594	3846	4111	4403	4708	5042	5766	6599	7555	8640	
	single blind								2 blinds on one headrail						3 blinds on one headrail				
Cordless	285								569						569				
LightMaster™	49	57	69	77	94	106	126	138	151	162	175	187	200	211	260	281	305	330	
Decorative Tapes (Solid)	41	49	57	61	73	81	89	113	122	130	138	147	155	162	200	211	224	228	
Decorative Tapes (Pattern)	81	85	106	118	138	162	187	207	228	248	272	285	309	326	394	423	443	443	

The maximum slat width is 96".

Cordless upgrade maximum height is 84". If width is greater than 84", it requires two blinds on one headrail.

Shaded area requires multiple blinds per headrail. To price multiple blinds on a headrail, see price above based on overall width then add appropriate surcharge from below.

FREE OPTIONS	
Must be requested at time of order.	
Choice of Control Options:	Tilter Left, Lift Cord Right (Standard) Tilter Right, Lift Cord Left All Right
Choice of Style Package:	Traditional (Standard) Contemporary (Optional)
Choice of Tilting Control on Corded:	Cord (not offered on Cordless) Wand
Extension Brackets (2" or 4")	
Extended Valance (Up to 3" greater than ordered width)	
Hold-down Brackets	

SURCHARGE OPTIONS	
Surcharges	
Cordless:	
1 Blind per Headrail	\$285
2 or 3 Blinds per Headrail	\$569
Cutouts (corded only):	
Side Cutout	\$77 per side
Decorative Tapes:	
½" Solid	See Grid For Price
1½" Solid	See Grid For Price
1½" Pattern	See Grid For Price
Extended Valance (3" and greater beyond order width)	\$85
LightMaster™	See Grid For Price
Multiple Blinds on One Headrail:	
2 Blinds per Headrail	\$147
3 Blinds per Headrail	\$187
Replacement Slat	\$7
Replacement Valance	\$85

## Price Group Q—2" Hardwood Blinds

### AVAILABLE FINISHES

520MS007 Authentic Cherry	520MS003 Oil Rubbed	520MS006 Summer Oak
520LS002 Brown Ash	520DS004 Rustic Hardwood	
520MS005 Caramel Oak	520LS007 Rustic Natural	

### AVAILABLE DECORATIVE TAPES

#### 1½" And ½" Solid Fabrics

00301 Autumn	00138 Flax	00140 Powder
00352 Beach	00755 Merlot	00110 Pure
WH005 Blossom	00890 Midnight	GY002 Smoke
70802 Chapel	00504 Pesto	GY003 Steam
00378 Coffee	00162 Poupon	

### AVAILABLE DECORATIVE TAPES

#### 1½" Pattern Fabrics

BR005 Coffee Leaves	01201 Glacier Ribbon	01237 Nautical Flax Stripe
BR003 Flora Cappuccino	BR002 Modern Filigree Flax	BR004 Threaded Flax
WH006 Flora Powder	NU008 Modern Filigree Stone	

## PRODUCT SPECIFICATIONS

### Ladder Spacing and Cord Count Charts

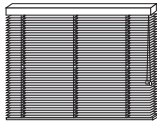
BLIND WIDTH				# OF TAPES OR LADDERS	# OF LIFT CORDS ON CORDED BLIND	# OF CORDS WITH CORDED PRIVACY	
INSIDE MOUNT MINIMUM	INSIDE MOUNT MAXIMUM	OUTSIDE MOUNT MINIMUM	OUTSIDE MOUNT MAXIMUM				
6½"	36½"	6"	36"	2	2	4	60" WIDE HARDWOOD
36⅝"	54½"	36⅝"	54"	3	2	4	
54⅝"	60½"	54⅝"	60"	3	3	6	
60⅝"	84½"	60⅝"	84"	4	4	8	
84⅝"	96½"	84⅝"	96"	5	3	6	

### Single Blind Minimum and Maximum Limitations

	MINIMUM WIDTH	MAXIMUM WIDTH	MINIMUM HEIGHT	MAXIMUM HEIGHT
Corded—Same Side Lift Controls with or without Tapes	20½"	96"	10"	120"
Corded—Opposite Side Lift Controls without Tapes	11½"	96"	10"	120"
Corded—Opposite Side Lift Controls with Tapes	13¼"	96"	10"	120"
Center Tilt, No Lift Control without Tapes	9"	11⅜"	8"	120"
Center Tilt, No Lift Control with Tapes with Tapes	9"	13⅜"	8"	120"
No Tilt or Lift Control with or without Tapes	7¼"	8⅞"	8"	120"
Cordless with or without Tapes	12½"	90"	10"	84"

See price grids for more details.



### Stacking Chart—Height Includes Headrail

BLIND HEIGHT	24"	36"	42"	48"	54"	60"	66"	72"	84"	96"	108"	120"
2" Slats	3¾"	4½"	5"	5½"	5¾"	6¼"	6½"	6¾"	7½"	8¼"	9"	10"

Stacking dimensions are approximate.

# Price Group Q—2" Hardwood Blinds

Finishes available: Caramel, Brown Ash, Authentic Cherry, Rustic Natural, Oil Rubbed, Rustic, Summer Oak

PRICE GROUP Q																		
	Width to																	
	16"	23"	31"	36"	42"	48"	54"	60"	66"	72"	78"	84"	90"	96"	108"	120"	132"	144"
Height to 30"	372	477	614	713	781	849	958	1142	1184	1216	1504	1590	1671	1790	2201	2376	2580	2761
36"	417	523	667	802	942	1057	1192	1332	1442	1581	1736	1839	1969	2104	2574	2788	3036	3227
42"	484	608	755	885	1041	1166	1311	1501	1622	1754	1942	2055	2250	2401	2931	3195	3441	3683
48"	541	677	823	963	1124	1270	1441	1622	1776	1940	2136	2309	2537	2693	3321	3600	3875	4166
54"	582	734	911	1046	1244	1415	1597	1828	2003	2167	2422	2591	2774	2974	3634	3963	4282	4583
60"	651	792	966	1108	1379	1582	1779	2035	2226	2426	2693	2882	3098	3294	4024	4374	4721	5072
66"	703	864	1037	1190	1519	1717	1973	2226	2447	2653	2936	3179	3407	3639	4457	4841	5215	5605
72"	765	935	1164	1280	1655	1895	2134	2447	2675	2963	3213	3444	3710	3958	4863	5280	5692	6109
Cordless 78"	828	1041	1275	1525	1779	2035	2311	2632	2947	3213	3472	3732	4012	4369	5280	5720	6191	6636
available up to 84"	914	1132	1401	1675	1961	2236	2526	2893	3169	3444	3732	4039	4374	4687	5659	6137	6631	7108
90"	995	1239	1552	1839	2152	2455	2774	3098	3396	3715	4012	4402	4715	5044	6082	6603	7125	7635
96"	1038	1298	1644	1969	2277	2628	2947	3314	3634	3953	4364	4726	5050	5396	6548	7092	7663	8222
102"	1120	1400	1762	2113	2465	2838	3178	3579	3897	4270	4610	4990	5401	5757	6933	7536	8135	8721
108"	1164	1455	1834	2217	2574	2991	3337	3743	4111	4484	4846	5226	5632	6022	7278	7899	8513	9161
114"	1222	1532	1927	2333	2706	3145	3513	3897	4320	4709	5099	5522	5933	6340	7663	8311	8964	9634
120"	1284	1603	2014	2437	2843	3287	3689	4051	4523	4945	5340	5786	6224	6636	8019	8711	9391	10099
	single blind								2 blinds on one headrail								3 blinds on one headrail	
Cordless	285								569								569	
LightMaster™	49	57	69	77	98	110	126	138	155	166	179	191	203	215	264	289	309	337
Decorative Tapes (Solid)	32	41	49	53	66	73	81	98	106	113	122	130	138	147	179	191	207	224
Decorative Tapes (Pattern)	69	77	94	106	126	147	166	187	203	224	240	256	277	292	354	382	415	443

The maximum slat width is 96".

Cordless upgrade maximum height is 84". If width is greater than 84", it requires two blinds on one headrail.

Shaded area requires multiple blinds per headrail. To price multiple blinds on a headrail, see price above based on overall width then add appropriate surcharge from below.

FREE OPTIONS
Must be requested at time of order.
Choice of Control Options: Tilter Left, Lift Cord Right (Standard) Tilter Right, Lift Cord Left All Left All Right
Choice of Style Package: Traditional (Standard) Contemporary (Optional)
Choice of Tilting Control on Corded: Cord (not offered on Cordless) Wand
Extension Brackets (2" or 4")
Extended Valance (Up to 3" greater than ordered width)
Hold-down Brackets

SURCHARGE OPTIONS	
Surcharges	
Cordless:	
1 Blind per Headrail	\$285
2 or 3 Blinds per Headrail	\$569
Cutouts	
Side Cutout	\$81 per side
Decorative Tapes:	
1/2" Solid	See Grid For Price
1 1/2" Solid	See Grid For Price
1 1/2" Pattern	See Grid For Price
Extended Valance (3" and greater beyond order width)	\$73
LightMaster™	See Grid For Price
Multiple Blinds on One Headrail:	
2 Blinds per Headrail	\$118
3 Blinds per Headrail	\$151
Replacement Slat	\$7
Replacement Valance	\$73

# Exploded View for 2½" and 2" Slat Blinds

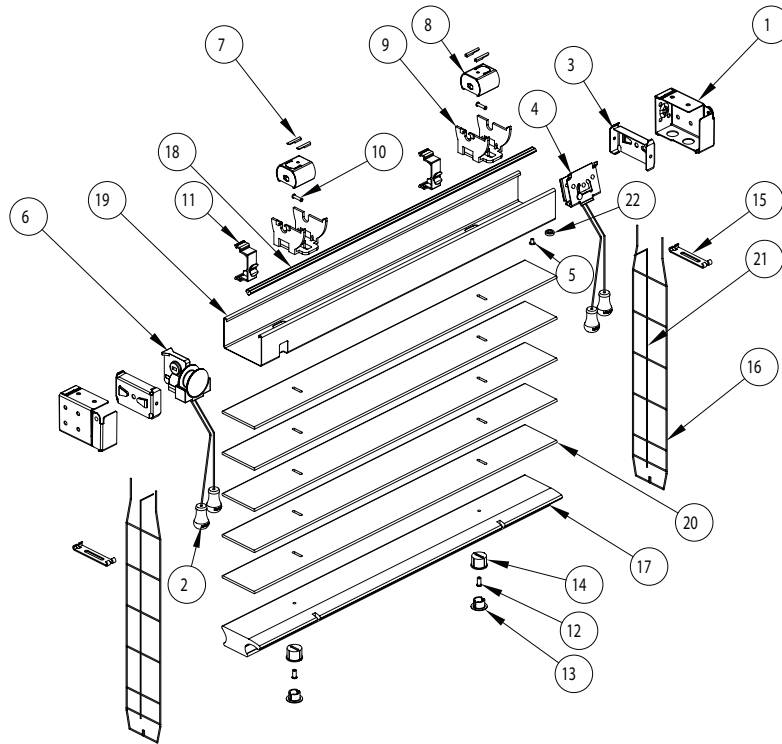

## 2½" AND 2" SLAT BLINDS PARTS LIST

Item	Description	Part Number				
		2 ½" Hardwood†	2" Hardwood and 2" Hardwood Classique™ Value	2" Variance™ and 2" Variance Classique Value	2 ½" Resemblance™	2" Faux Wood and 2" Faux Wood Classique Value
NS	Wand Tilter			*HMTL0023*		
NS	Wand Protector			QV763401		
NS	Screw Pack			K04L612400050		
NS	Wand (12", 24", 36", 48")		*HGWN0077*			*HGWN0074*
NS	Hinged Wand (60", 72", 84", 96")		*HGWN0079*			*HGWN0078*
1	Installation Bracket			*F01E*		
2	Tassel - Classique™ Value Package		*HGTS0032*			*HGTS0030*
2A	Tassel - Modern or Traditional Package		*HGTS0025*			*HGTS0026*
3	End Brace			F09U000000010		
4	Cordlock			F10C000000010		
5	Cordlock Rivet			DWL0841000050		
6	Cord Tilter			HTML0019		
7	Ladder Top Rivet			H03B000000010		
8	Tilt Drum – no Twill Tapes			F13M000000010		
8A	Tilt Drum – with Twill Tapes			H13D200100010		
9	Cradle – Standard, no Twill Tapes			F13B000000010		
9A	Cradle – Standard, with Twill Tapes			F13T000000010		
9B	Cradle – Privacy Left			W13L700000010		
9C	Cradle – Privacy Right			W13L800000010		
10	Cradle Pin			COMES WITH CRADLE		
11	Valance Clip			HFCP0002		
12	Ladder Bottom Rivet			M13G7920		
13	Ladder Cap			*WB505*		
14	Ladder Cap Retainer			1870073		
15	Slat Clip	W14S2500	W22T0000	W22T0000	W14S2500	W22T0000
16	Ladder – Standard	*CL250003*	*DK091602*	*DK091602*	*CL250003*	*DK091602*
16A	Ladder – Privacy	*CL250004*	*T30A*/*T30B*	*T30A*/*T30B*	*CL250004*	*T30A*/*T30B*
17A	Bottomrail - Classique™ Value Package	N/A	*W19T*	*K19P*	N/A	*K19P*
17	Bottomrail - Modern or Traditional Package	*RABR0050*	*RABR0049*	*RABR0047*	*RABR0048*	*RABR0047*
18	Tilt Rod			E20P030000010		
19	Headrail			*F50A300*		
20	Slat	*S25W*	*S97Z*	*S95F*	*S25P*	*S96P*
21	Lift Cord - Standard			*C98*		
21A	Lift Cord - Privacy			*C88*		
22	Safety Donut			DDW30445		

† wand tilt parts now shown NS = Not Shown

# Exploded View for 1" Premium Hardwood Blinds

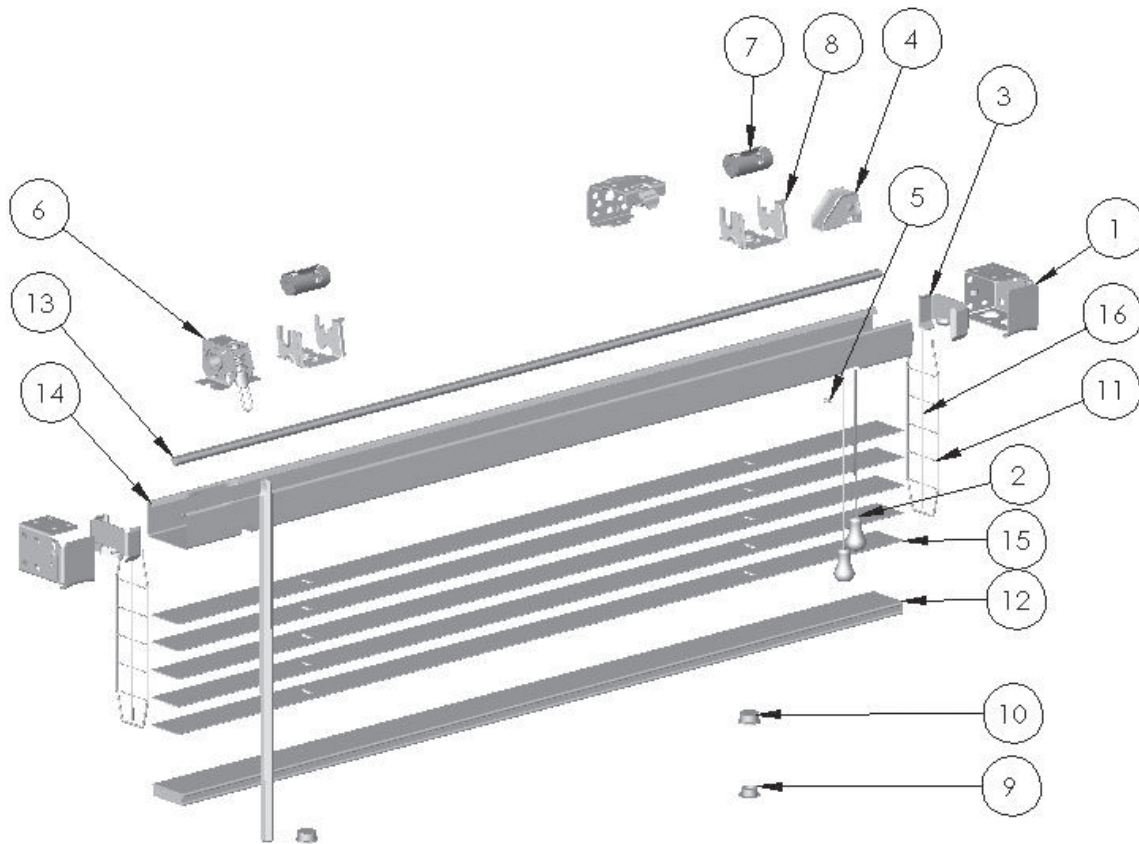

## 1" PREMIUM HARDWOOD BLINDS PARTS LIST

Item	Description	Part Number
NS	Valance Clip	1870058
NS	Tassel	K04L612400050
1	Installation Bracket	*K01E*
2	Tassel	*HGTS0025*
3	End Brace	K09E040000010
4	Cordlock	K10K000000010
5	Safety Donut	DDW30445
6	Wand Tilter	K11A000000010
7	Tilt Drum - no twill tapes	K13Y000000010
7A	Tilt Drum - with twill tapes	K13T000000010
8	Cradle - standard, no twill tapes	K13C000000010
8A	Cradle - standard, with twill tapes	DWL5206300010
9	Ladder Cap	*WB505*
10	Ladder Cap Retainer	1870073
11	Ladder	*DK091701*
12	Bottomrail	*L19W*
13	Tilt Rod	E20P030000010
14	Headrail	*K50A*
15	Slat	*S98Z*
16	Lift Cord - Standard	*C98*
16A	Lift Cord - Privacy	*C88*
	*NS = Not Shown	

### Cleaning and Care Instructions

Keep your Kirsch® wood and faux wood blinds looking their best by periodically wiping them with a soft cloth, a dusting mitt, or the brush attachment from a vacuum cleaner.

- You can clean the blind hanging in place or you can take it down.
- By tilting the slats down, but not quite closed, you'll be able to clean most of the top surface of each slat.
- Do not use water, solvents, or abrasive solutions to clean the blind. This will cause damage to the blind which is not covered under warranty.
- Premium Hardwood Blinds: In very dusty environments, you may use a non-wax furniture polish to clean the blind.
- Variance and Visions™ Faux Wood Blinds: You may use a soft, lightly dampened cloth to clean your faux and composite wood blinds.
- Blinds with Privacy: Slats can be removed for cleaning. Slide out the slat, wipe clean, and return to its original position.
- With the tighter closure of Privacy, any slight warpage could be noticeable; simply flip the slat over to cover the light gap.

## Terms and Conditions

### Order Processing

#### Telephone Orders

Verbal orders are accepted as the store's responsibility. Each order will be repeated back by the Customer Service Representative. In certain instances, we may require written orders.

#### Duplicated Orders

All orders are confirmed after entry into our system. Kirsch® Customer Service is not responsible for duplicate orders caused by a written order following a telephone order or duplicate faxes.

#### Changes and Cancellations

All products are custom-made to your specifications under tight deadlines. Once production has begun on your order, changes and cancellations cannot be made.

#### Contract Orders

All Contract Orders must be processed through Contract Customer Service at 1-800-826-8021.

#### Freight

- Freight for custom blind orders within the continental U.S. will be prepaid. (Excludes Alaska, Hawaii, Puerto Rico and the U.S. Virgin Islands.)
- Shipments outside the continental U.S. are subject to freight charges.
- Chargeable parts and returns for repair are subject to freight charges.

#### Pricing and Terms

All prices are subject to change without notice.

### Claims and Returns

#### Defective Merchandise

All manufacturing defects must be reported to Customer Service within 30 days of receipt of blinds. We may require the return of defective blinds prior to repair or replacement.

#### Incorrect Merchandise

If any part of your shipment was made incorrectly, please advise Customer Service within 30 days. A replacement will be made at no charge if the problem was due to Kirsch® error. If the problem was due to dealer or customer error, the original order and replacement order will be full charge.

#### Returns for Repair

Prior to return for repair, contact Customer Service. We will request the order number, date, purchase order number, and type of product. Arrangements for return will be made at that time with directions as to how the blinds should be returned. The package should be marked for easy identification both inside and outside, and should contain a written confirmation of the verbal repair instructions. Repairs should be packaged carefully. Product that has been mishandled or received in poor condition will be returned to the customer.

Chargebacks for unauthorized repairs or additional installation cannot be honored. All returns for repair are subject to freight charges.

### Returns for Credit

Returns can be accepted only if prior authorization has been obtained from Customer Service. Authorization will include instructions as to how the merchandise should be returned. Unauthorized returns will be refused.

#### Freight Damage FedEx/FedEx Ground:

- If freight damage is visible, refuse the shipment. FedEx will inspect the damage and return to the shipping location. Contact Customer Service for further information.
- If freight damage is concealed, retain all packaging materials and contact Customer Service immediately (must be notified within 14 days).

#### Freight Damage Common Carrier: (All shipments FOB shipping point)

- If freight damage is visible, refuse the shipment. The carrier will return the merchandise to the shipping location for inspection. Contact Customer Service for further information.
- If freight damage is concealed, retain all packaging materials and contact Customer Service immediately (must be notified within 14 days).



At Kirsch, we're committed to making products and relationships that last. That's why we offer a product with a complete warranty and a no-risk exchange policy.

#### No Risk Exchange Policy

Whether you mis-measured or simply changed your mind, if you don't love your custom Kirsch for any reason, we'll exchange it within 30 days of receipt.

#### Full 10-year Warranty

Your investment will last. If any part of your custom Kirsch breaks or is damaged due to poor workmanship or defect within 10 years of purchase, we'll repair or replace it free of charge.

# kirsch®



kirsch.com

Kirsch Window Fashions ©2015  
3 Glenlake Parkway, Atlanta, GA 30328  
1-800-225-1988 • 1-800-545-2325 fax • www.kirsch.com  
A **NewellRubbermaid**™ Brand



1939129