

## Blackout Instructions

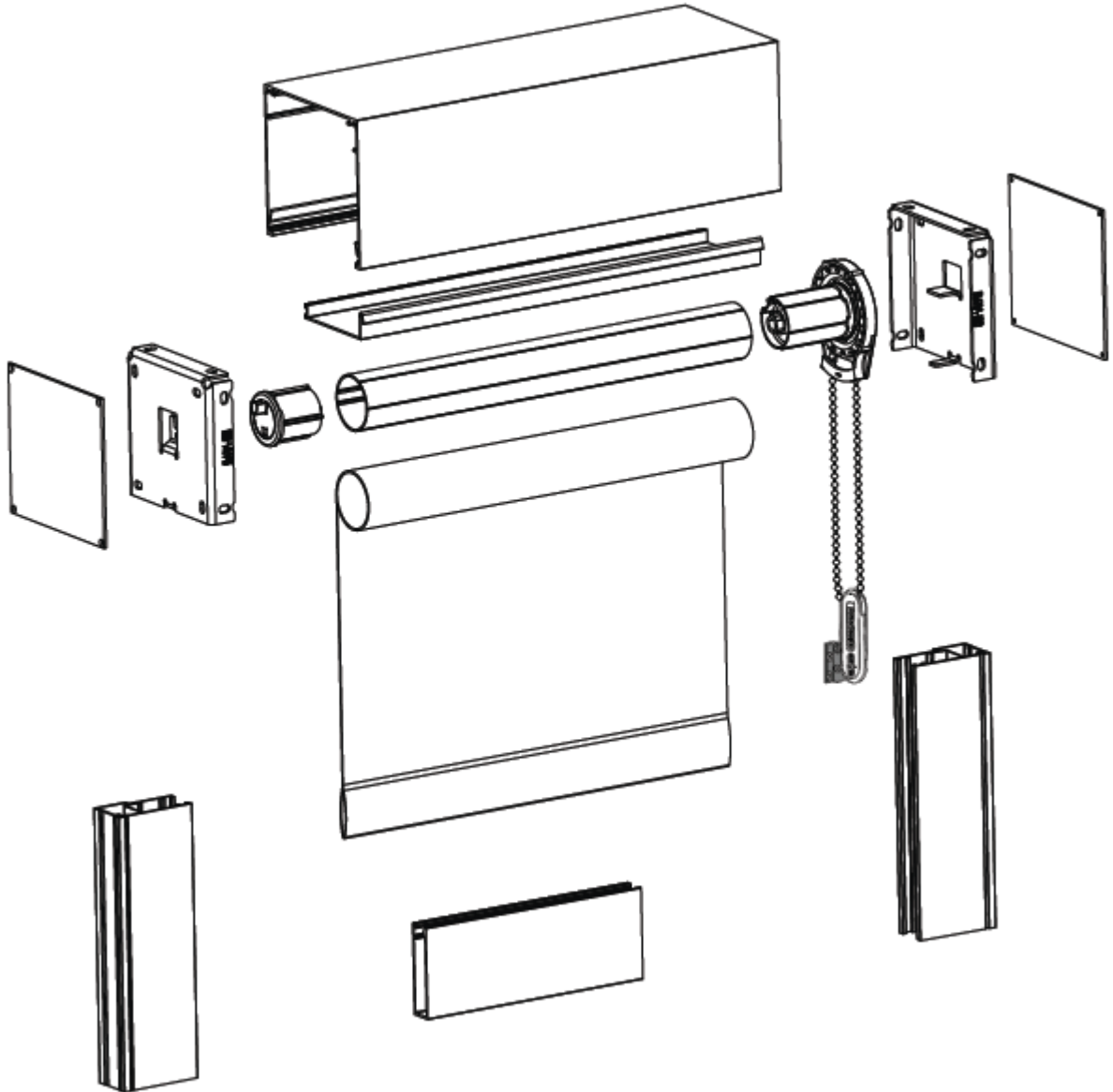





### 4" R-Series Pocket Installation – Outside Mount



<i>Components Needed</i>	_____	<i>page 3</i>
<i>Tools Needed</i>	_____	<i>page 4</i>
<i>System Diagram</i>	_____	<i>page 5</i>
<b><i>Instructions</i></b>		
<b>Step 1: Install Pocket.</b>	_____	<b>Page 6</b>
<b>Step 2: Install Brackets</b>	_____	<b>Page 6</b>
<b>Step 3: Install End Plates</b>	_____	<b>Page 7</b>
<b>Step 4: Mount Back Side Channels</b>	_____	<b>Page 7</b>
<b>Step 5: Install Shade</b>	_____	<b>Page 8</b>
<b>Step 6: Install Bottom Channel</b>	_____	<b>Page 9</b>
<b>Step 7: Install Front Side Channel</b>	_____	<b>Page 9</b>
<b>Step 8: Install Bottom Closure</b>	_____	<b>Page 10</b>
<b>Step 9: Install Tension Device</b>	_____	<b>Page 11</b>
<b>Installed Shade</b>	_____	<b>Page 11</b>

## Blackout Instructions

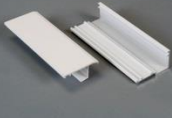
### 4" R-Series Pocket Installation Instructions

Quantity	Description	Image
1	4" Roller shade assembled to tube with clutch and idler inserted.	
2	4" R-Series Fascia Brackets	
2	End Plates	
1	4" Pocket	
1	Bottom Closure	
2	Front & Back Side Channels	
1	Bottom Channel	



## Blackout Instructions

### 4" R-Series Pocket Installation Instructions

#### Tools Needed

Screwdriver/Power Drill
1/16" Metal Drill Bit
Screws
Hammer/Mallet
Measuring Tape
Level
Ladder
Chisel
Center Punch
Eye Protection
Gloves

## System Diagram

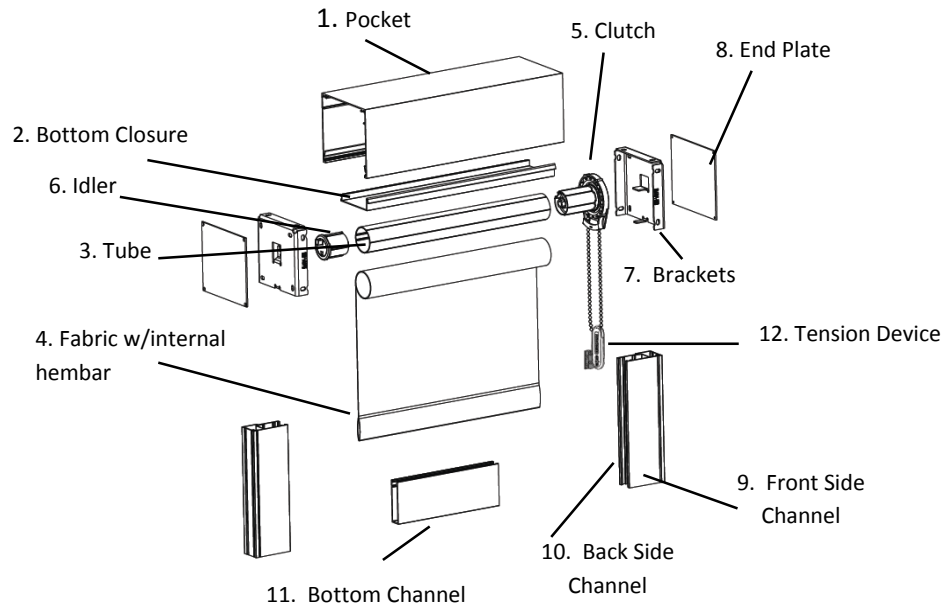

<b>1</b>	<b>4" Pocket</b>
<b>2</b>	<b>Bottom Closure</b>
<b>3</b>	<b>Tube</b>
<b>4</b>	<b>Fabric with internal Hembar</b>
<b>5</b>	<b>Clutch</b>
<b>6</b>	<b>Idler</b>
<b>7</b>	<b>4" R-Series Fascia Brackets</b>
<b>8</b>	<b>4" End Plates</b>
<b>9</b>	<b>Front Side Channel</b>
<b>10</b>	<b>Back Side Channel</b>
<b>11</b>	<b>Bottom Channel</b>
<b>12</b>	<b>Tension Device</b>

## Blackout Instructions

### 4" R-Series Pocket Installation Outside Mount

#### Step 1: Install Pocket

- 1a. Mark mounting screw hole locations with a center punch (Ceiling Mount Only)
- 1b. Pre-drill mounting holes
- 1c. Mount pocket to wall or ceiling using the appropriate mounting screws

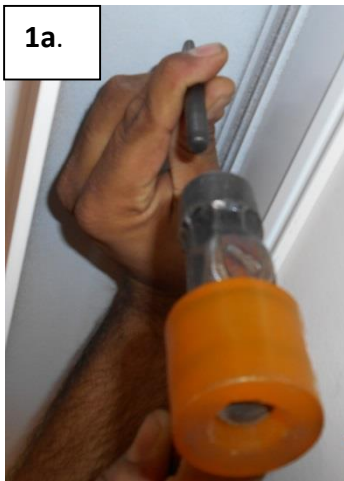

#### Step 2: Install Brackets

- 2a. Insert Bracket into pocket (may need mallet to gently tap bracket into place) until flush with end of pocket
- 2b. Secure bracket to pocket with supplied mounting screws OR:
- 2c. Secure bracket to pocket by staking pocket channel to bracket with a chisel.



**Step 3: Install End Plates**

3a. Insert End Plate screws into manufacturers pre-drilled holes in end plate and secure to pocket.



**Step 4: Mount Back Side Channels (follow steps for right and left back side channels)**

4a. Decide where to drill holes. Align Back channel under corner of pocket so that the side of the back channel is flush with the end plate and perpendicular to the pocket.

4b. Mark mounting screw hole locations with a center punch

4c. Pre-drill holes in the back of the side channel using 1/16" metal drill bit

4d. Re-align the back channel and mount with the correct mounting screws

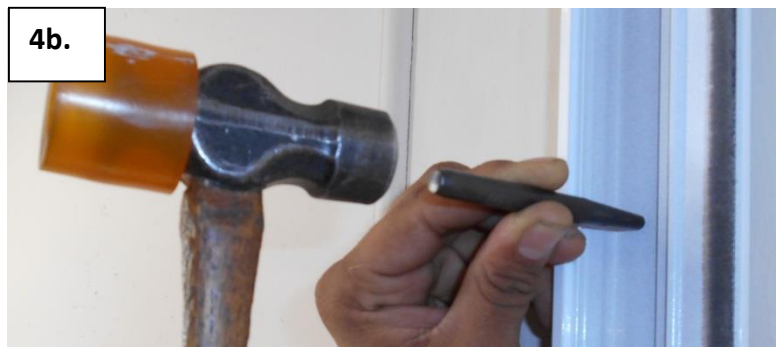
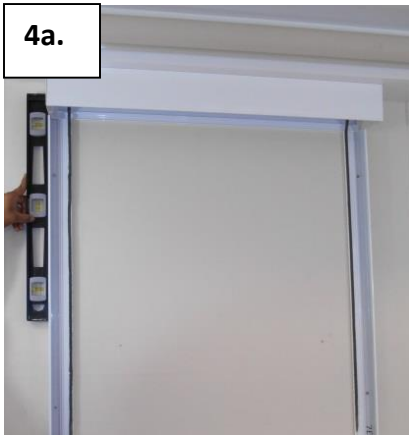

**Step 5: Install Shade**

**5a. Insert Clutch side first by placing the hole in the clutch onto the tab on the bracket.**

**5b. Insert Idler by pulling shade up and around the flag on the middle of the idler end bracket (keeping the flag open), then insert the tab on the idler in the bracket (be sure to close flag using lever)**

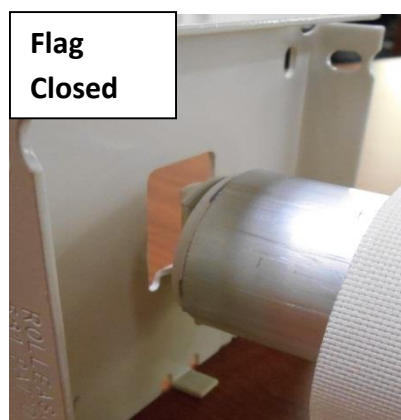
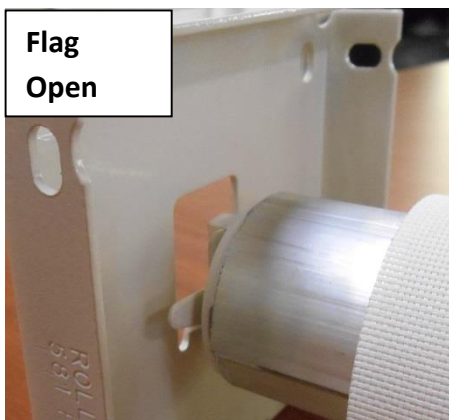
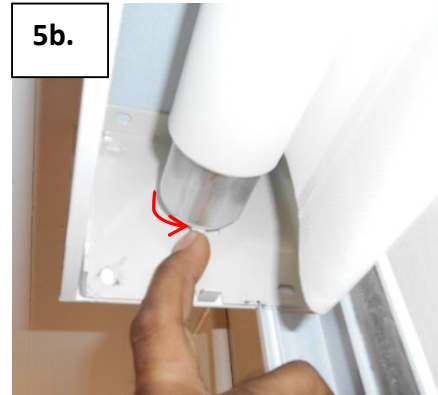
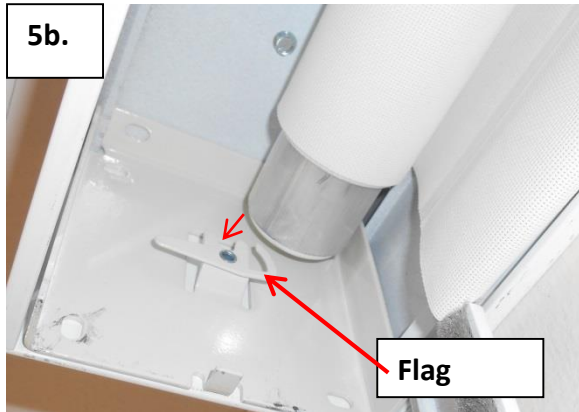



**Step 6: Install Front Side Channel**

6a. Snap front side channel by engaging lip of front side channel into the groove on the back side channel the snapping closed into place



Engage lip into groove



Snap into place



**Step 7: Install Bottom Channel**

7a. Place left side of bottom channel between the front and back side channels

7b. Slide the right side down in between the front and back side channels until the bottom closure is at the bottom of the side channels

7c. While holding the bottom closure in place, drill a a screw hole using a 1/16" metal drill bit 3/8" from the bottom left hand corner of the side and bottom channel and install mounting screw through both channels.through all channels and into the wall.

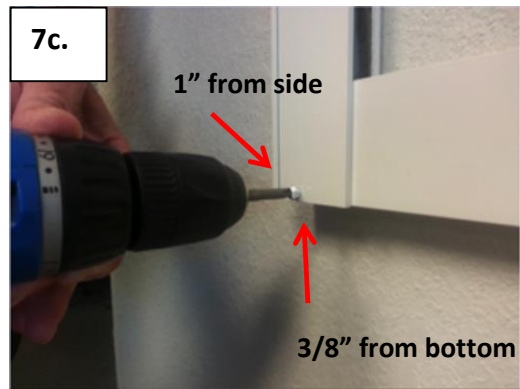
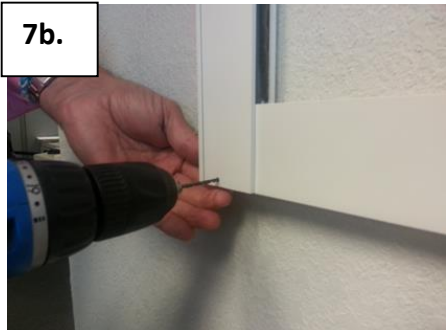

**Step 8: Install Bottom Closure**

8a. Insert bottom closure into pocket on an angle (as shown).

8b. Once it is aligned in shade, allow front of bottom closure to drop in place



Idler Side



Clutch Side



Idler Side

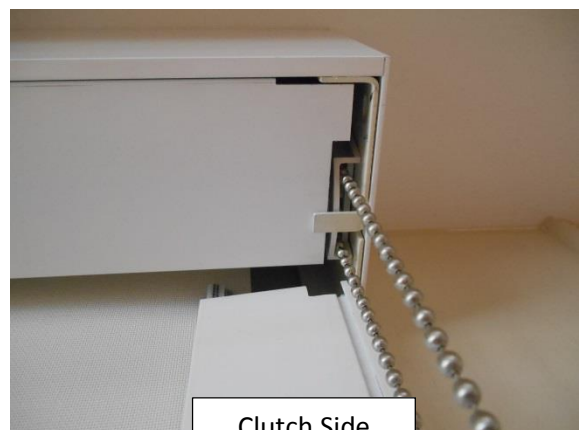

Clutch Side

**Step 9: Install Tension Device**



**Installed Shade**

